

PLAYSKOOL® PIPEWORKS™

With the 'CLICK-LOCK' LOCKING SYSTEM
Unique

Instruction Manual

**KID-SIZED
CONSTRUCTION SYSTEM
THAT'S A NEW TOY EVERY DAY!**

Parents: Please Read
This Guide Thoroughly
Before Using Pipeworks



Patent Pending

Feeling good about the Playskool years.

*Ages: 3 & up to play
Ages: 5 & up to build*

Introduction to Pipeworks™

LETTER TO PARENTS

Recommended for ages 3 and up for play; 5 and up for building
Maximum weight: 100 lbs. for vehicles
200 lbs. for climbing structures

Adult Supervision Recommended for Proper Use of this Toy
Pipeworks is a fun and exciting toy with endless possibilities. Before starting to play, parents should read this instruction manual completely. It's important to understand all there is to know about this fun and innovative building toy. PIPEWORKS allow children to create a variety of structures they can ride on, climb on and play with in imaginative new ways. Preschoolers will enjoy playing on structures they build with their parents while older kids will find building with PIPEWORKS fun and easy because of the unique "click-lock" connecting system. Parents should check all structures to be sure they are strong, stable and secure before allowing children to play on them. **Parents: Important safety tips are specially marked throughout this manual and parents should pay extra attention to these points.**



Children love to build with Pipeworks. Its extra large, kid-sized pieces and unique "click-lock" connecting system make it fun and easy to build with. However, it is important to instruct children as to what they should and shouldn't do on each structure. If they build a structure intended for climbing or riding, whether it's listed in this manual or not, an adult should check all tubes before play to be sure they are properly locked into position and that the structure is secure.

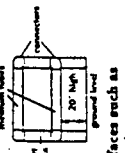

- When building climbing structures, do not use the configuration specified in the illustration when it is over 20" off the ground. This type of opening could provide enough room for a child's head to be trapped between the tubes.
- Climbing structures should be built on level surfaces such as grass or carpets and in an area free of all obstructions.
- Children should wear shoes and avoid wearing loose clothing that may entangle when playing with Pipeworks.
- All tubes should be properly locked into position.
- For maximum stability, climbing structures should not be more than 48" high.
- Avoid jumping on and off climbing structures.
- Build climbing structures without open ends of tubes pointing up.
- Avoid using Pipeworks in or around swimming pools.
- Using other building materials with Pipeworks is not recommended.

Safety Recommendations for Parents

- As with any ride-on toy, proper supervision and common sense are important for the safe use of this product. Again, it is important to instruct children as to what they should and shouldn't do on a ride-on. A Ride-on will roll on any surface that is even slightly sloped. Parental supervision is recommended.
- All Ride-ons should enable children to get in and out easily.
 - All Ride-ons should be used near swimming pools, on or near hills, roadways or stairways.
 - Ride-on toys are not to be used where they are properly locked into position and that the vehicle is secure and stable.
 - Ride-ons are meant for one rider at a time.
 - Ride-on seats should be under 12" high for maximum stability.
 - Do not jump on or off or stand on ride-ons.
 - Building 3 Wheeled Ride-ons is not recommended because of instability.
 - Check ALL Ride-ons for rear and side stability with child in place before use.

Tips for Good Builders

- Always hold the back of each connector so you don't pinch your fingers between the tube and connector.
- Build from the bottom up and from the center out.
- Never leave a tube over a connector in an unlocked position as this weakens the locks.
- Climbing structures should not be more than 48" high.
- When building anything for climbing, use a "STRAIGHT" vertically and not horizontally.
- All pipe-venches should be removed from holes in tubes after an assembly has been completed.
- Wheels should always be constructed with axles and caps.
- To provide adequate support, all panels should be constructed with a tube under all 4 sides.
- Hinged structures should be designed to swing from side to side and not up and down.
- Dismantling is easier if you use several keys at once and unlock tubes at both ends.
- Any connector with faulty or missing locks should be returned to Pipeworks for replacement. (See 800 number on back page).
- Building swings is not recommended due to their instability.
- All climbing structures should be as wide as they are high.
- When building climbing structures, tubes should be supported at every joint.
- When building climbing structures, use long tubes vertically and not horizontally.
- Each type of connector is a different color. Just follow the colors in the photograph when building.

Contents of Kits

Basic Set 1000

- 1 panel
- 8 short tubes
- 13 medium tubes
- 3 pipe-venches
- 4 axles
- 4 caps
- 4 panel clips
- 4 wheels
- 4 box corners
- 4 four ways
- 6 elbows
- 2 tees
- 2 grippers

Big Builders Set 2000

- 3 panels
- 10 short tubes
- 42 medium tubes
- 4 pipe-venches
- 8 box corners
- 2 straight
- 12 panel clips
- 10 four ways
- 2 elbows
- 6 tees
- 4 grippers

Deluxe Set 3000

- 3 panels
- 12 short tubes
- 48 medium tubes
- 4 pipe-venches
- 4 axles
- 4 caps
- 4 wheels
- 8 box corners
- 2 straight
- 12 panel clips
- 8 four ways
- 12 elbows
- 10 tees
- 4 grippers

Guide to Instructions

How to Assemble Your Pipeworks™ Set

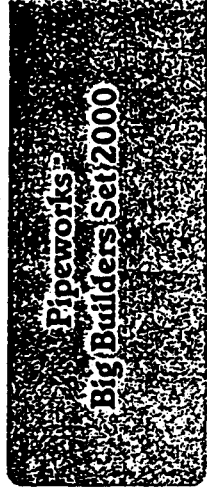

How to build with Pipeworks™

When building with Pipeworks, follow these basic steps to assure that all your constructions are safe, sturdy and secure.

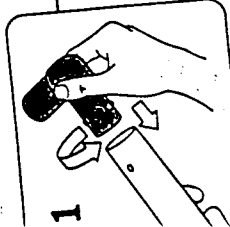

1 Slide the tube over the connector and rotate it until you hear it click into position. The locks on the connector should now be inside the holes in the tube. Always hold the back of each connector so you don't pinch your fingers between the tube and connector.

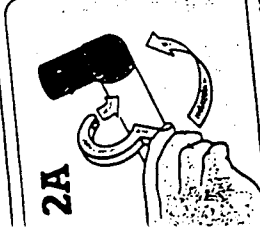

2A To unlock a tube from a connector, slowly twist the tube off. If the tube is connected at both ends, kids can use another pipe wrench at the other end to make disassembling easier.

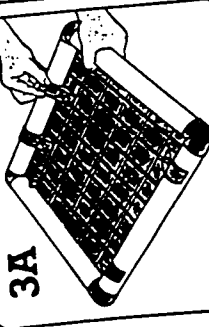
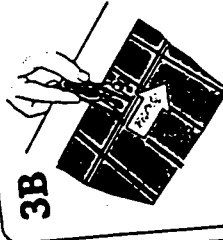
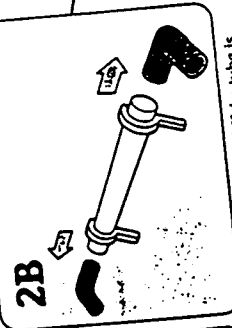

3A To attach panels to tubes, slide tabs on clip sideways into the slots on the back of the panel. Be sure tabs click into position. When using panels, be sure they are supported with tubes on all four sides.

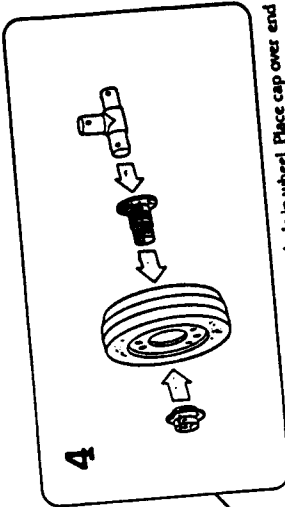

4 To attach wheel, insert axle into hole in wheel. Place cap over end of axle and lock into position. Then attach to appropriate connector as specified in pictures.

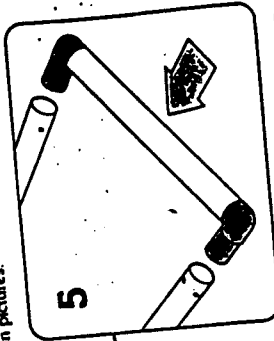

5 Assemble angle connectors and straight pipes as a unit before connecting to adjacent sides of squares or rectangles.

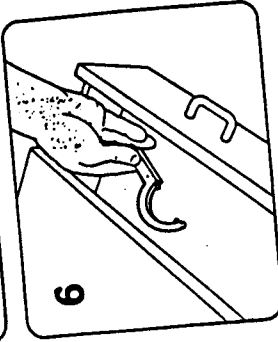

6 Parents: We recommend you keep one of the Pipeworks in a safe place in case the other Pipeworks are misplaced. More Pipeworks are available for purchase. See Paris Order Form at the end of the book.

Works™ Wheelbarrow Instructions

Use four panel clips to attach two medium tubes to a panel.

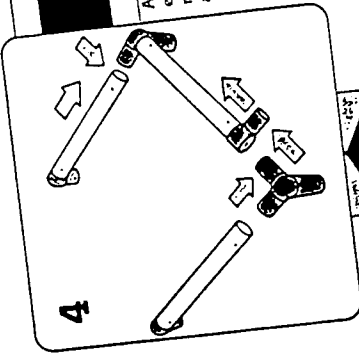
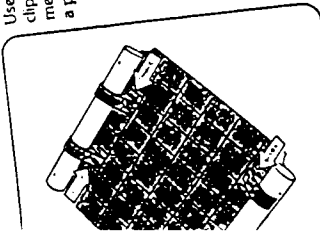

Attach two blue elbows to two medium tubes. Slide an orange gripper over a medium tube and attach a red box corner to each end. Complete assembly as shown.

Snap connectors onto tubes on panel as shown.

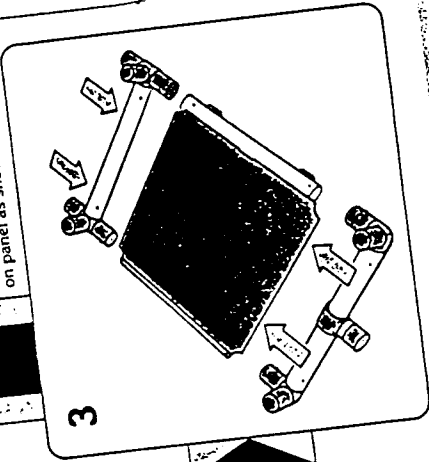

Snap two green, four-way connectors onto a medium tube. Slide one orange gripper onto a medium tube and then attach two red box corners.

To assemble wheelbarrow handle, attach two blue elbows to a medium tube. Attach a medium tube to open end of each elbow. Snap handle assembly onto open ends of wheelbarrow. To disassemble wheelbarrow, use Pipeworks™ "pipewrench" and reverse the order of the instructions.

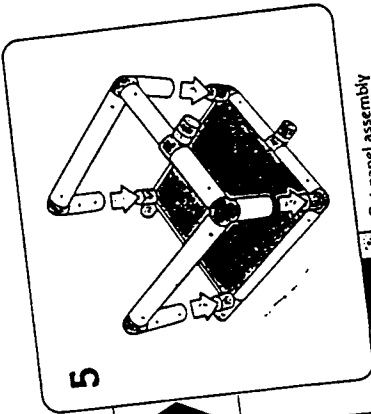

5

Put panel assembly down on flat surface and attach assembly using four short tubes.

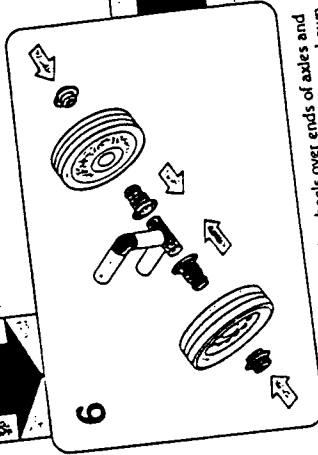

To assemble wheels, slide wheels over ends of axles and snap on caps. Attach wheels to green four way as shown. Attach two short tubes to green four way. Attach elbow to another short tube and assemble as shown.

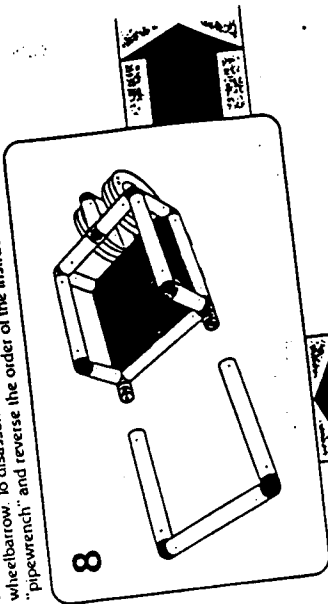

8

Place open ends of wheel assembly over end of orange grippers.

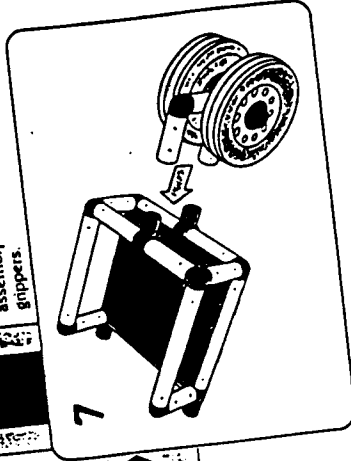

7

Wheelbarrow

SIC SET 1000

works Construction Sets let you build all kinds of things! This action manual shows you how to make 13 different creations with Basic Set or larger sets. Use your imagination and see how many different things you can build with Pipeworks!

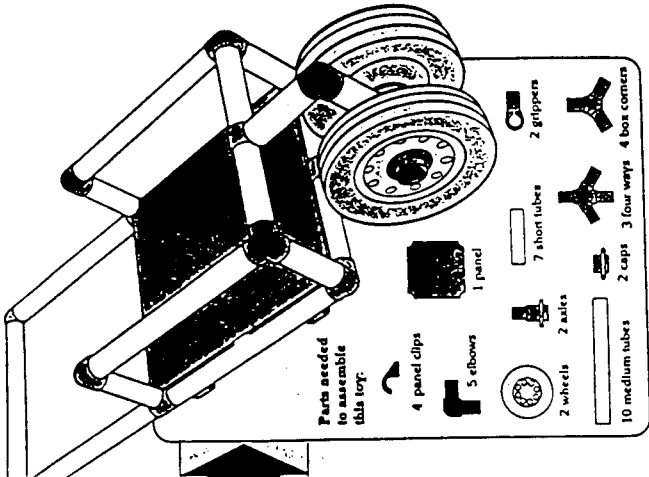

The wheelbarrow should not be used as a ride-on.

Basic Set 1000

Chairs

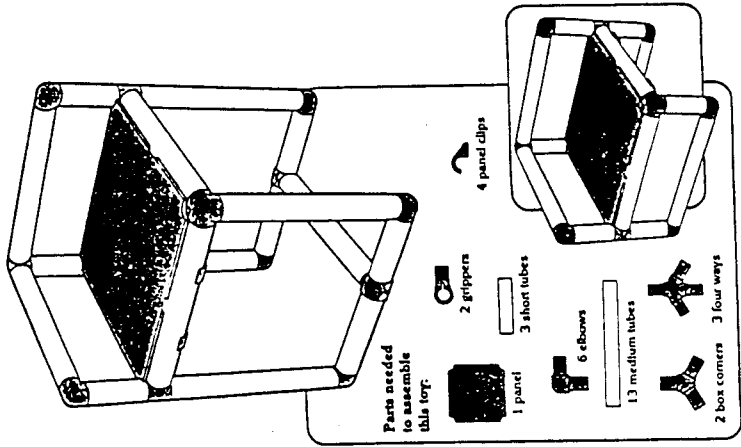

All panels should be constructed with a tube under all 4 sides.

8

Table

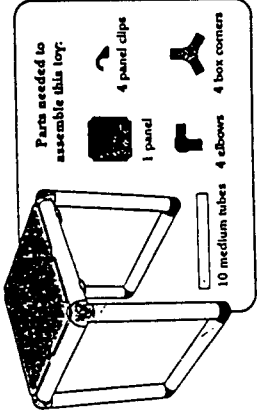

Easel

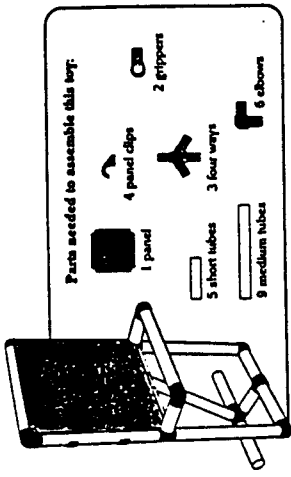

Riding Horse

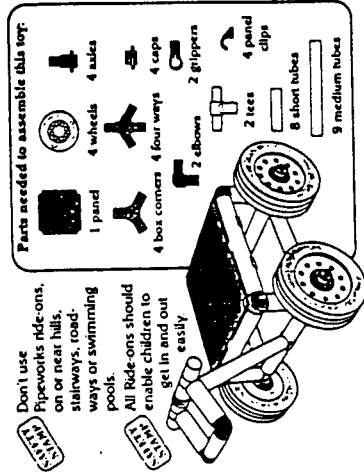

Don't use Pipeworks ride-ons, on or near hills, stairways, roadways or swimming pools. All Ride-ons should enable children to get in and out easily.

Don't use Pipeworks ride-ons, on or near hills, stairways, roadways or swimming pools. All Ride-ons should enable children to get in and out easily.

Pick-up Truck

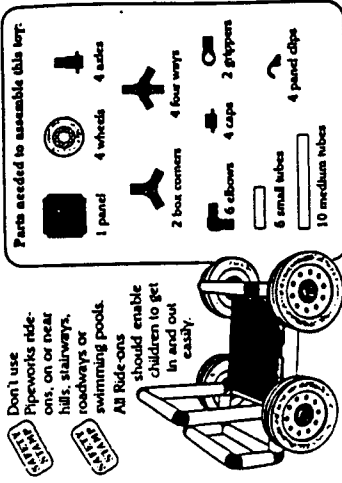







Basic Set 1000

9

Hurdle





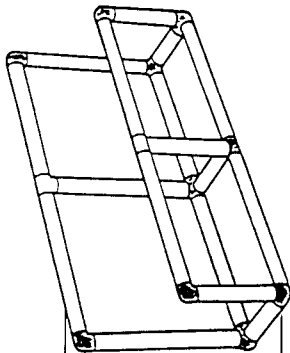





Parts needed to assemble this toy:

-  6 short tubes
-  11 medium tubes
-  4 elbows
-  2 four ways
-  2 tees
-  4 box corners



Test Driver

Parts needed to assemble this toy:



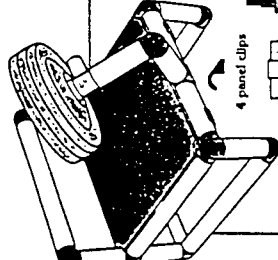









-  4 panel clips
-  8 short tubes
-  8 medium tubes
-  1 panel
-  1 axle
-  1 tee
-  1 gripper
-  4 box corners
-  1 wheel
-  1 cap
-  2 four ways



Helicopter

Ride on toys are not to be used near swimming pools, on or near hills, roadways or stairways. All Ride-ons should enable children to get in and out easily.





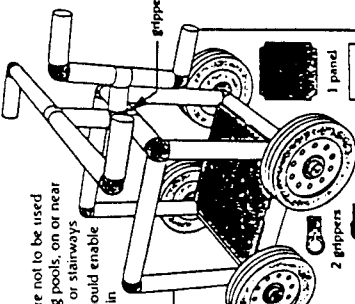





Parts needed to assemble this toy:

-  4 caps
-  4 axles
-  4 wheels
-  2 tees
-  2 grippers
-  4 four ways
-  2 box corners
-  4 panel clips
-  1 panel
-  6 elbows
-  8 short tubes
-  13 medium tubes



Tea Cart

Parts needed to assemble this toy:

-  1 panel
-  4 axles
-  4 wheels
-  4 panel clips
-  4 box corners
-  4 short tubes
-  13 medium tubes
-  4 elbows
-  2 grippers
-  4 four ways

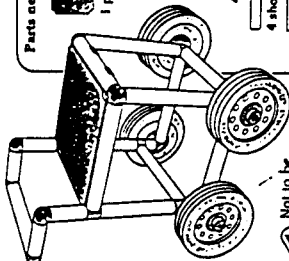











Not to be used as a Ride-on.

Mini-Car

Don't use Pipeworks ride-ons on or near hills, stairways, roadways or swimming pools. All Ride-ons should enable children to get in and out easily.

Parts needed to assemble this toy:



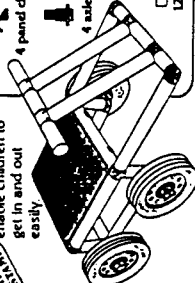





-  1 panel
-  4 panel clips
-  4 wheels
-  2 elbows
-  4 box corners
-  4 axles
-  2 tees
-  4 four ways
-  2 grippers
-  7 short tubes
-  12 medium tubes



Small Wagon

Don't use Pipeworks ride-ons on or near hills, stairways, roadways or swimming pools. All Ride-ons should enable children to get in and out easily.

Parts needed to assemble this toy:



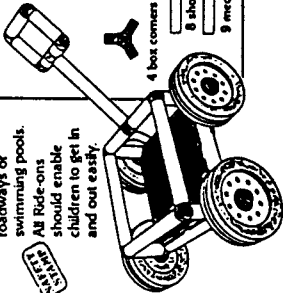







-  4 panel clips
-  4 wheels
-  4 axles
-  4 elbows
-  4 four ways
-  4 box corners
-  8 short tubes
-  9 medium tubes
-  2 grippers



Mini-Scooter

Don't use Pipeworks ride-ons on or near hills, stairways, roadways or swimming pools. All Ride-ons should enable children to get in and out easily.

Parts needed to assemble this toy:

-  1 panel
-  4 panel clips
-  4 wheels
-  2 grippers
-  2 four ways
-  4 axles
-  4 caps
-  2 tees
-  5 short tubes
-  5 medium tubes

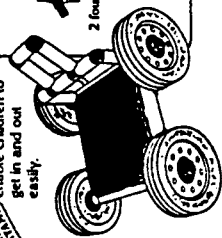







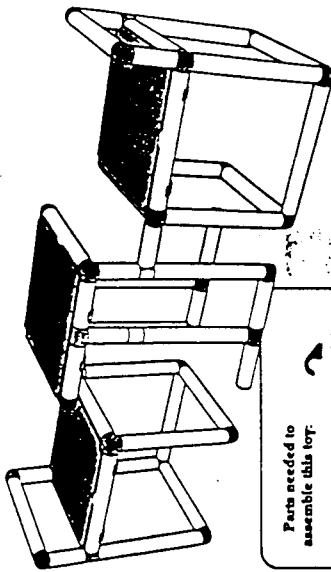



Picnic Table with chairs

BIG BUILDERS SET 2000

The Pipeworks Construction Set lets you build all kinds of things! This instruction manual shows you how to make 14 different creations with the Big Builders Set or larger sets. Use your imagination and see how many different things you can build with Pipeworks.











Parts needed to assemble this toy:

-  3 panels
-  2 tees
-  4 grippers
-  10 short tubes
-  34 medium tubes
-  12 panel clips
-  12 elbows
-  6 four ways
-  8 box corners
-  2 straights

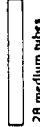
Bridge

Parts needed to assemble this toy:

-  3 panels
-  12 panel clips
-  2 box corners
-  6 short tubes
-  28 medium tubes
-  2 straights
-  10 elbows
-  8 four ways
-  2 tees

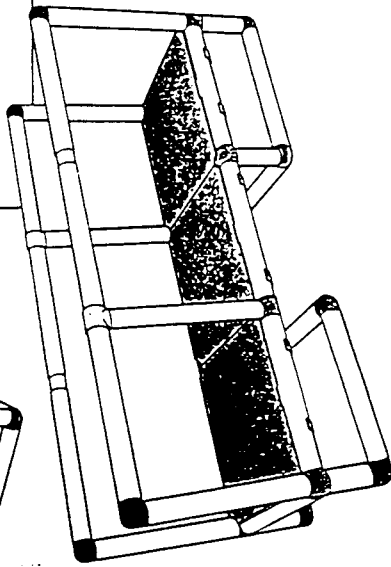

Fort

Climbing structures should not be more than 48" high.

Be sure all climbing structures are stable and secure before play.

For maximum stability, climbing structures should be used as pictured in the instructions.

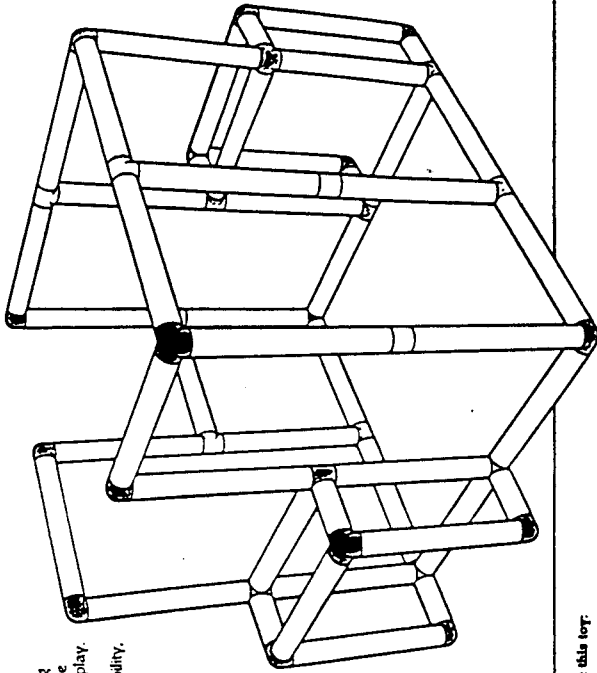

Parts needed to assemble this toy:

-  8 short tubes
-  39 medium tubes
-  2 straights
-  8 elbows
-  8 box corners
-  8 four ways
-  6 tees

Small Monkey Bars

Bench

Lemonade Stand

Climbing structures should not be more than 48" high.

Be sure all climbing structures are stable and secure before play.

For maximum stability, climbing structures should be used as pictured in the instructions.

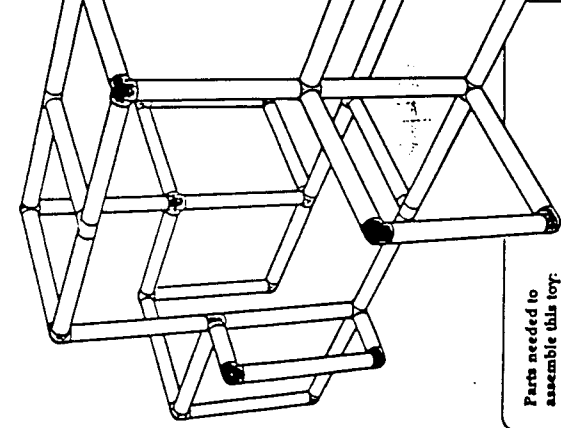

Parts needed to assemble this toy:

- 4 short tubes
- 42 medium tubes
- 8 box corners
- 12 elbows
- 8 four ways
- 4 tees

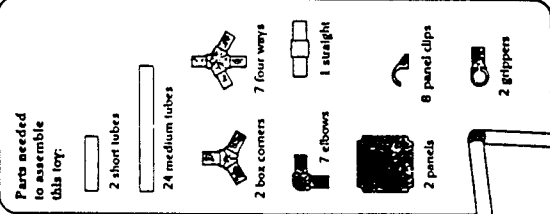

Parts needed to assemble this toy:

- 2 short tubes
- 24 medium tubes
- 4 box corners
- 7 four ways
- 7 elbows
- 1 straight
- 8 panel clips
- 2 grippers

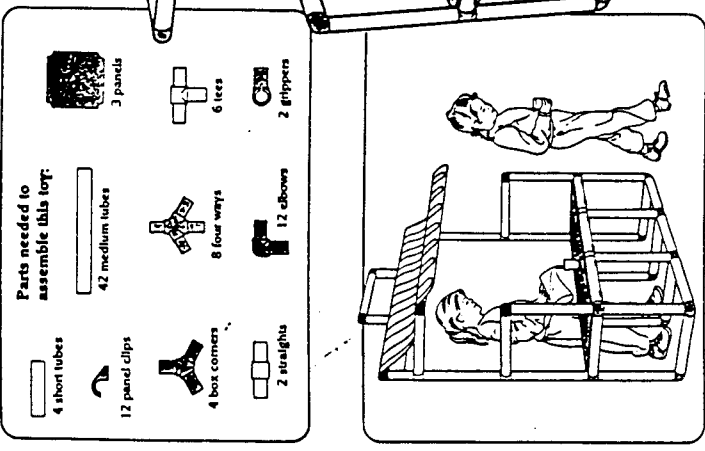

Parts needed to assemble this toy:

- 4 short tubes
- 12 panel clips
- 4 box corners
- 2 straight
- 42 medium tubes
- 8 four ways
- 12 elbows
- 6 tees
- 2 grippers

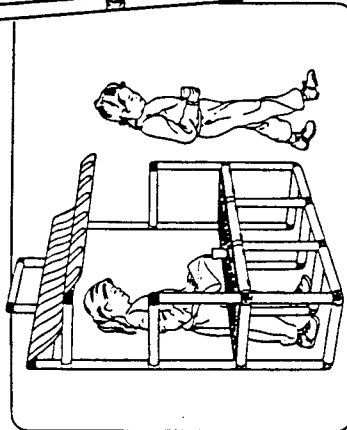

Use a colorful cloth or towel for a canopy.



Do not swing on canopy support.

Tall Chair

Because of its height, this chair is not recommended for younger children.

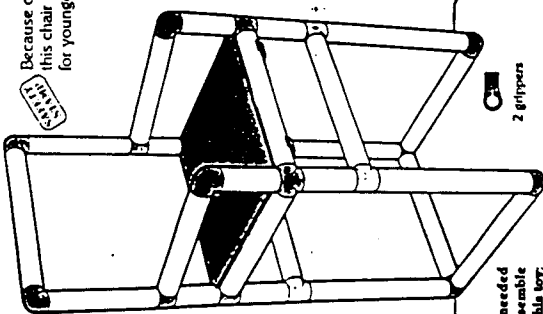

Parts needed to assemble this toy:

- 1 panel
- 6 short tubes
- 18 medium tubes
- 4 panel clips
- 2 grippers
- 4 legs
- 4 four ways
- 2 box corners
- 6 elbows

Tunnel

Parts needed to assemble this toy:

- 3 panels
- 12 panel clips
- 4 box corners
- 8 four ways
- 26 medium tubes
- 4 elbows

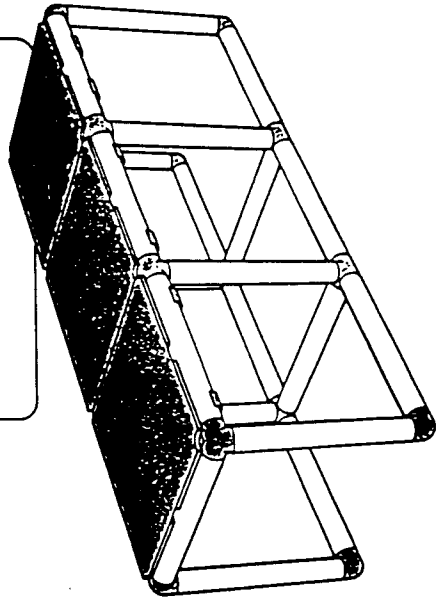

Obstacle Course

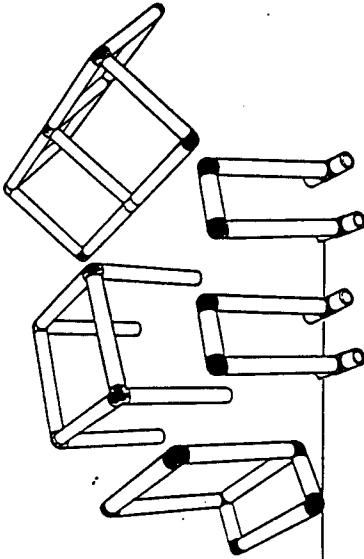

Parts needed to assemble this toy:

- 8 short tubes
- 29 medium tubes
- 8 box corners
- 2 legs
- 1 four way
- 4 grippers
- 12 elbows

Slide

Parts needed to assemble this toy:

- 3 panels
- 12 panel clips
- 8 short tubes
- 31 medium tubes
- 10 four ways
- 2 box corners
- 6 elbows
- 2 angles

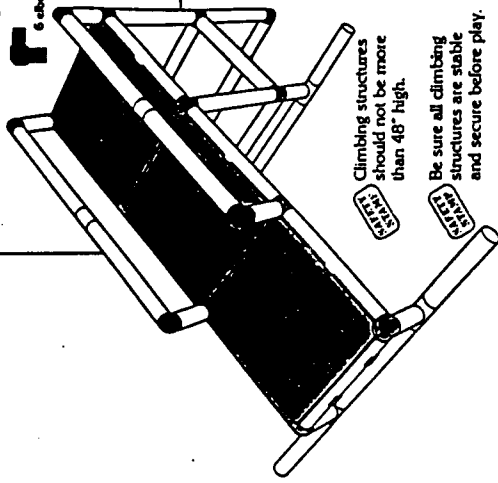

WARNING
CLIMBING

Climbing structures should not be more than 48" high.

WARNING
CLIMBING

Be sure all climbing structures are stable and secure before play.

WARNING
CLIMBING

For maximum stability, climbing structures should be used as pictured in the instructions.

Slide

Easel

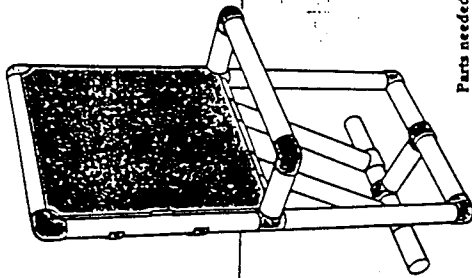

Parts needed to assemble this toy:

- 2 tees
- 6 short tubes
- 10 medium tubes
- 4 clips
- 1 panel
- 4 grippers
- 2 four ways
- 6 elbows

Desk

Use grippers here as used on front of desk

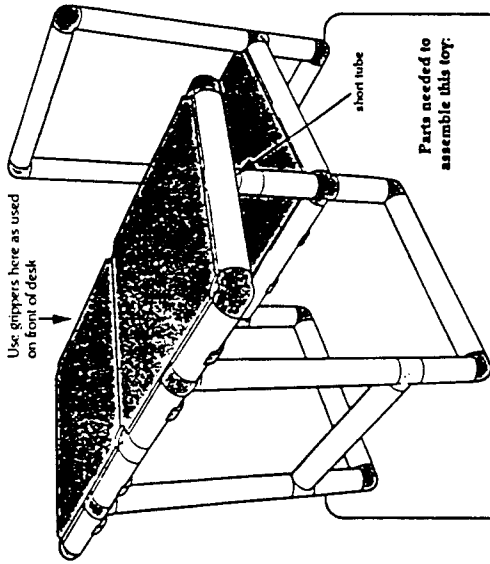

Parts needed to assemble this toy:

- 4 grippers
- 10 short tubes
- 20 medium tubes
- 12 panel clips
- 3 panels
- 4 four ways
- 4 tees
- 12 elbows
- 2 straight

Small Climbing Structure

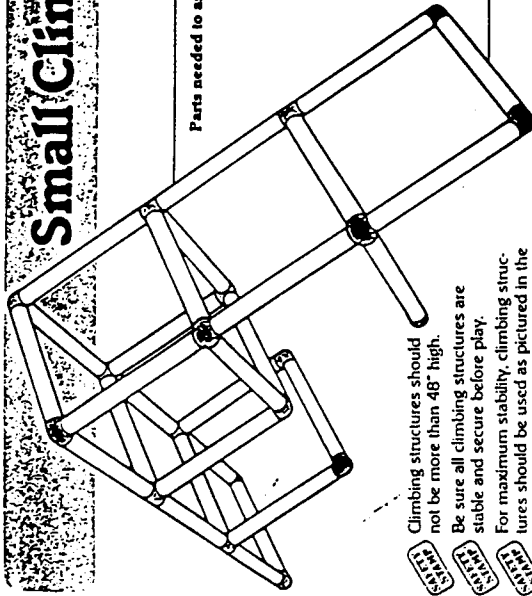

Parts needed to assemble this toy:

- 30 medium tubes
- 4 box corners
- 8 elbows
- 8 four ways

Climbing structures should not be more than 48" high. Be sure all climbing structures are stable and secure before play. For maximum stability, climbing structures should be used as pictured in the instructions.



Soccer Goal

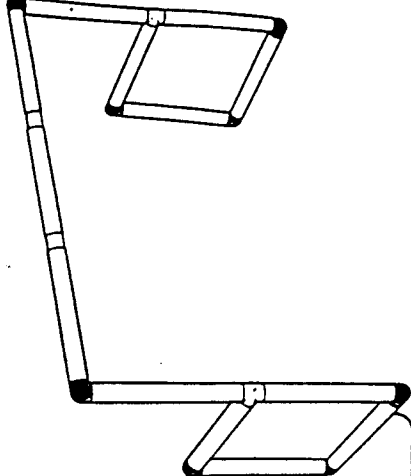

Parts needed to assemble this toy:

- 2 tees
- 13 medium tubes
- 2 straight
- 8 elbows

The Pipeworks™ Deluxe Set 3000 can build all items in this instruction manual.

Refer to previous pages for instructions that show you how to build these and other toys.

DELUXE SET 3000

The Pipeworks Construction Set lets you build all kinds of things! This instruction manual shows you how to make 29 different creations with the Deluxe Set. Use your imagination and see how many different things you can build with Pipeworks.

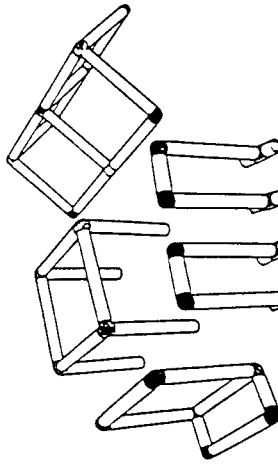

Beach Chair
See Big Builders Set 2000
Tan Section, Page 14

Obstacle Course
See Big Builders Set 2000
Tan Section, Page 17

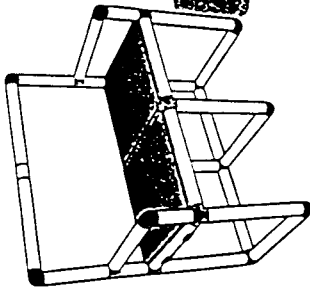

Tall Chair
See Big Builders Set 2000
Tan Section, Page 16

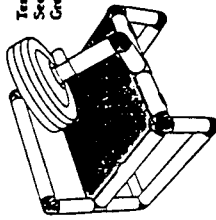

Easy!
See Big Builders Set 2000
Tan Section, Page 18

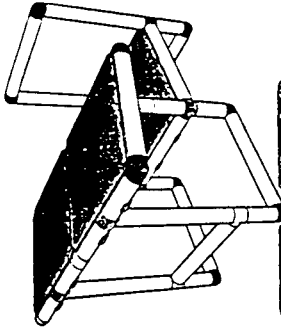
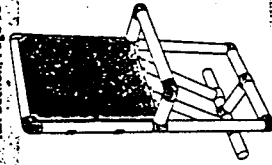

Desk
See Big Builders Set 2000
Tan Section, Page 18

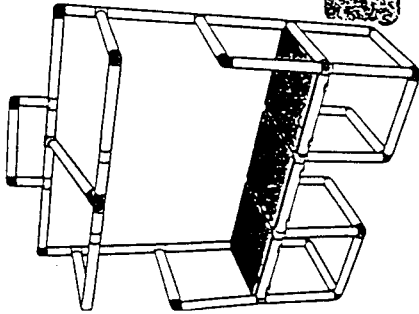

Laminated Sheet
See Big Builders Set 2000
Tan Section, Page 15

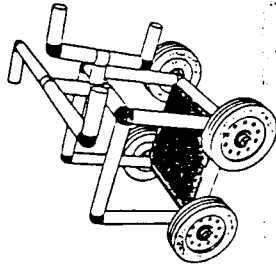

Helicopter
See Basic Set 1000
Green Section, Page 10

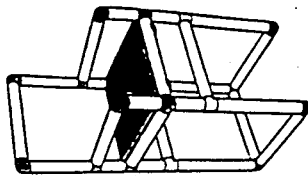

Tall Chair
See Big Builders Set 2000
Tan Section, Page 16

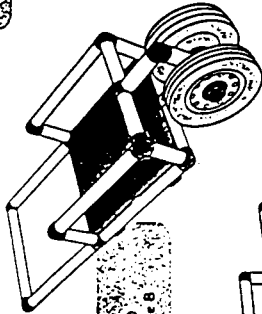

Wheelbarrow
See Basic Set 1000
Green Section, Page 8

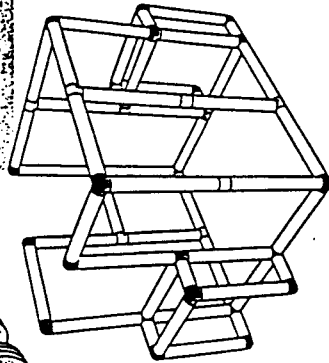

Feet
See Big Builders Set 2000
Tan Section, Page 13

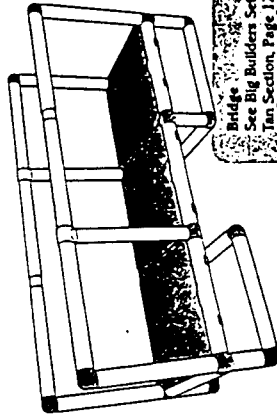

Bridge
See Big Builders Set 2000
Tan Section, Page 12

Monkey Bars

WARNING
Climbing structures should not be more than 48" high.

WARNING
Be sure all climbing structures are stable and secure before play.

WARNING
For maximum stability, climbing structures should be used as pictured in the instructions.

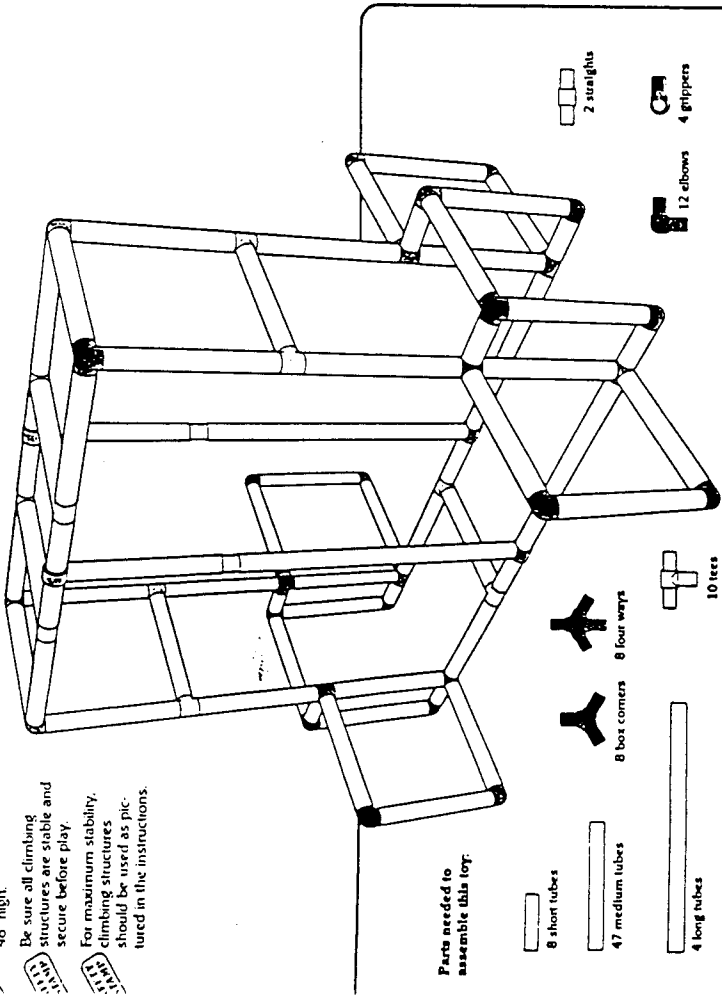

Jungle Gym

WARNING
Climbing structures should not be more than 48" high.

WARNING
Be sure all climbing structures are stable and secure before play.

WARNING
For maximum stability, climbing structures should be used as pictured in the instructions.

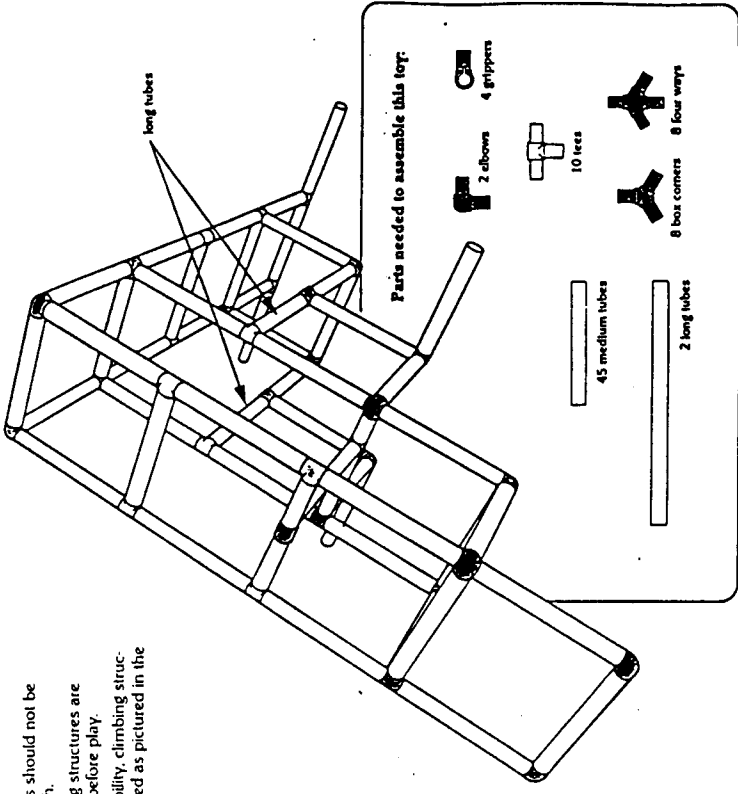

Jungle Gym





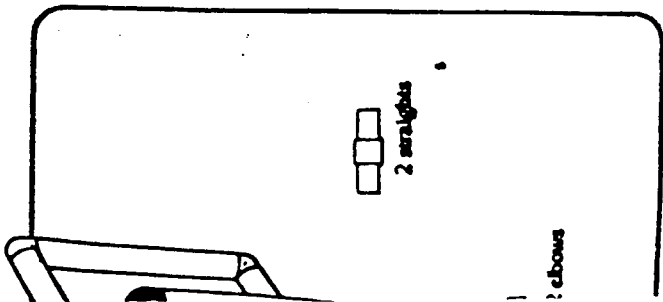
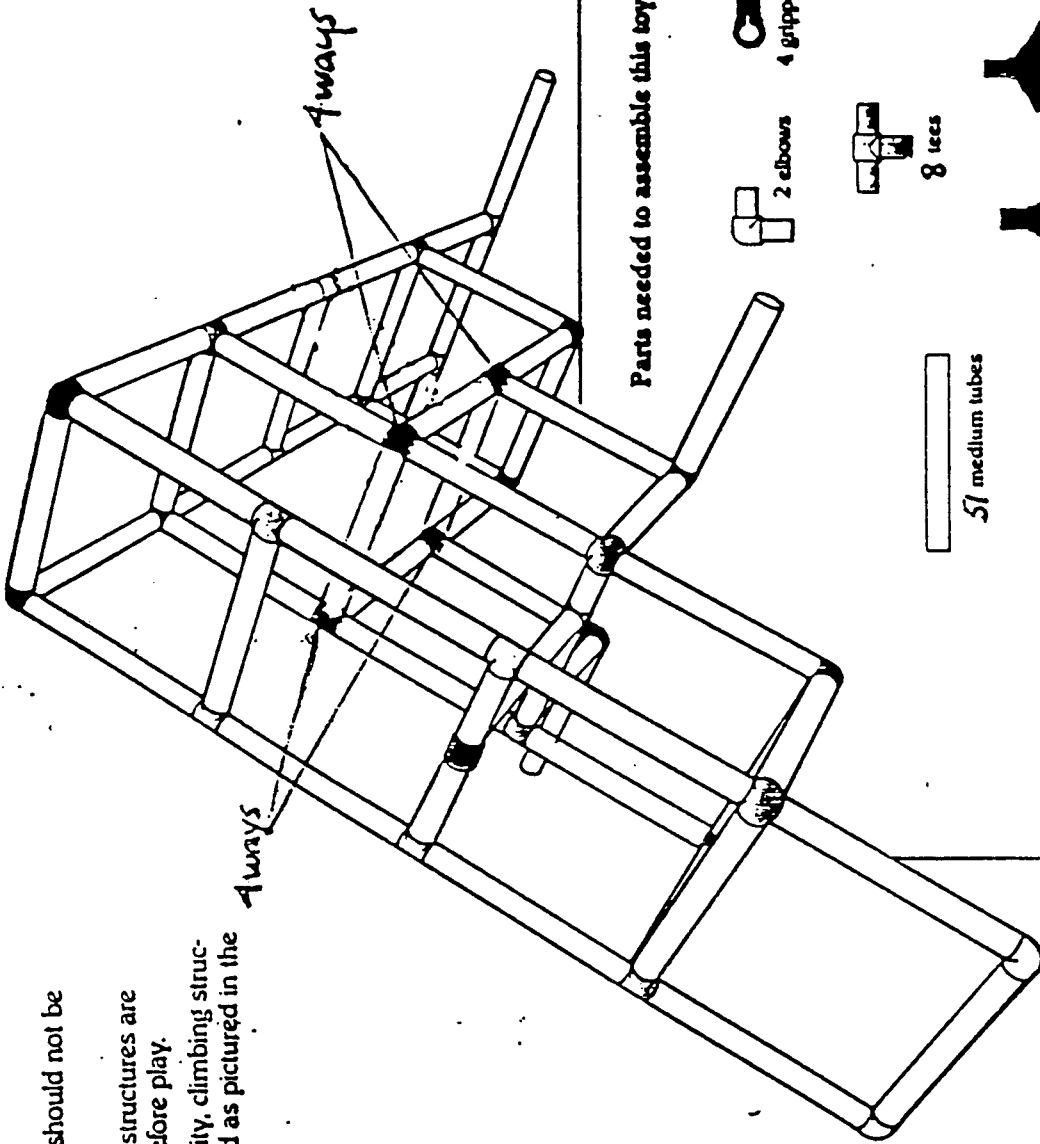

Climbing structures should not be more than 48" high.

Be sure all climbing structures are stable and secure before play.

For maximum stability, climbing structures should be used as pictured in the instructions.



Parts needed to assemble this toy:

-  2 elbows
-  4 grippers
-  8 tees
-  8 box corners
-  12 four ways
-  51 medium tubes

Climbing structures should not be more than 48" high.
 Be sure all climbing structures are stable and secure before play.
 For maximum stability, climbing structures should be used as pictured in the instructions.

Climbing structures should be more than 48" high.
 Be sure all climbing structures are stable and secure before play.
 For maximum stability, climbing structures should be used as pictured in the instructions.

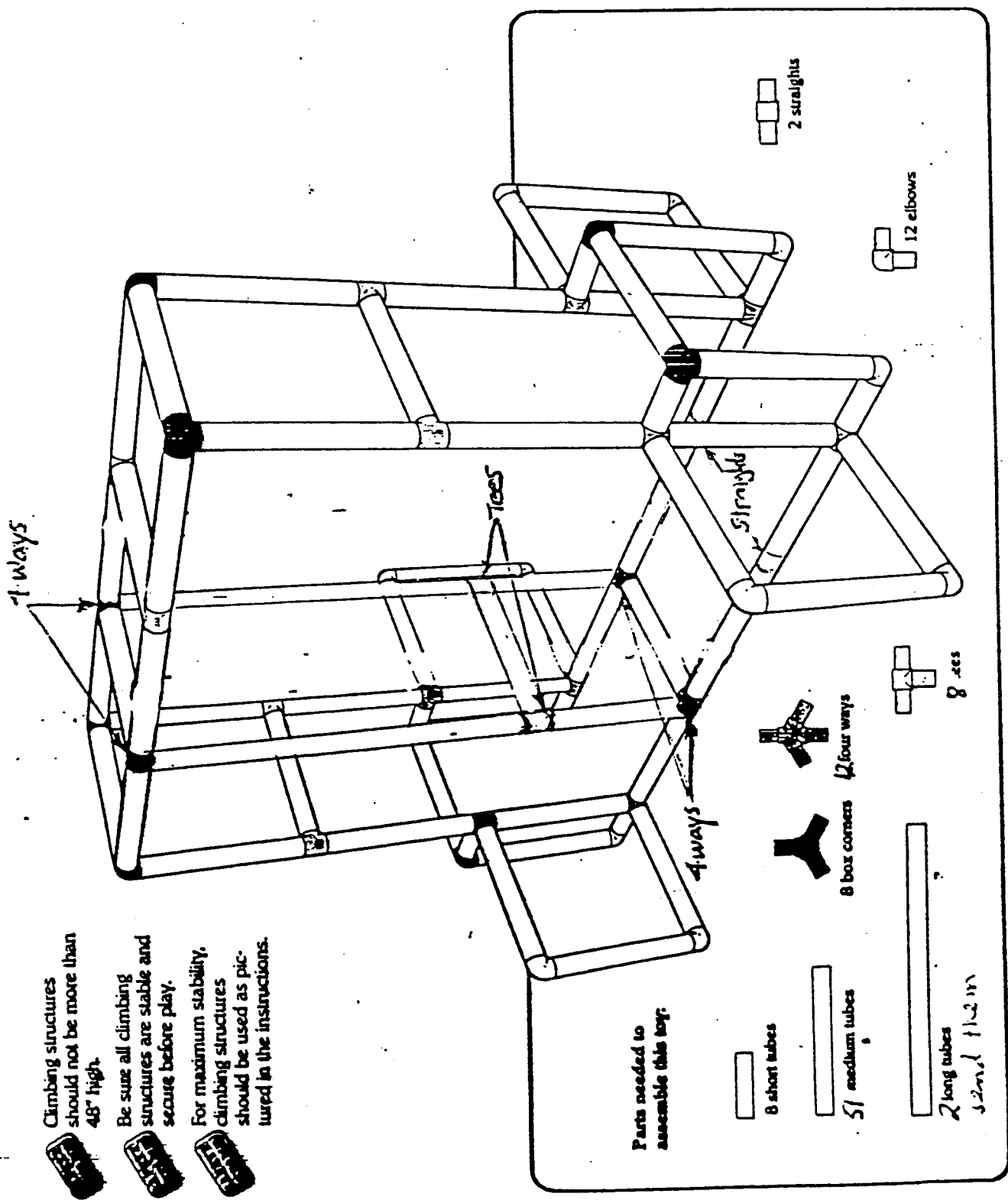

Parts needed to assemble this toy:

8 short tubes

51 medium tubes

2 long tubes standard 1 1/2 in



8 box corners



2 four ways

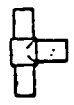

8 8-ways



12 elbows



2 straights

Go-Cart

ride-ons, on
ys, roadways

enable
d



12 short tubes
16 medium tubes

- 4 elbows
- 4 grippers
- 4 panel clips
- 6 box corners
- 4 four ways

Wagon

Don't use Pipeworks ride-ons, on
or near hills, stairways, roadways
or swimming pools.

All Ride-ons should enable
children to get in and
out easily.

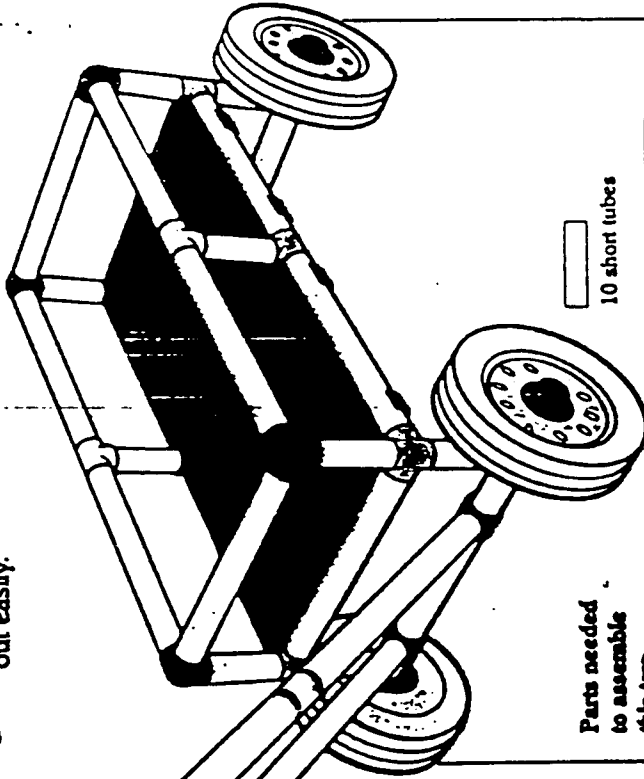

Parts needed
to assemble
this toy:

10 short tubes
medium tubes

- 2 elbows
- 2 grippers
- 2 panels
- 4 box corners
- 4 axes
- 4 wheels
- 6 four ways
- 6 tees
- 8 panel clips

Steerable Jalopy

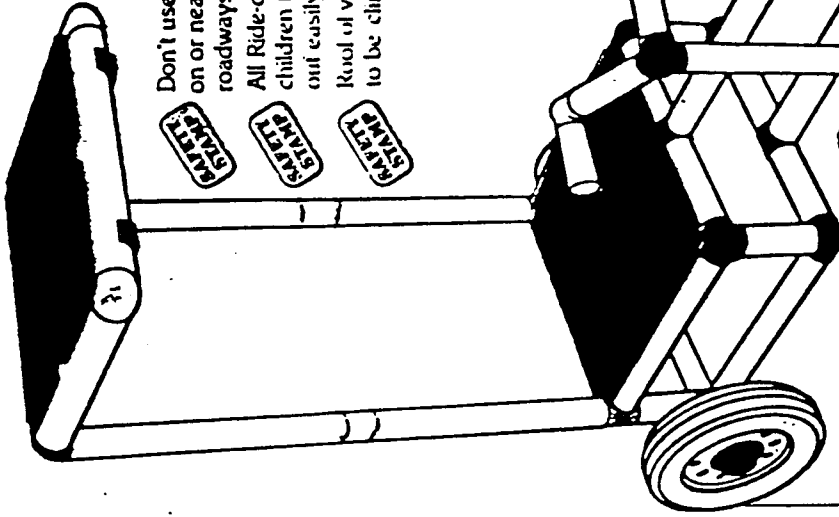

Don't use Pipeworks ride-ons,
on or near hills, stairways,
roadways or swimming pools.
All Ride-ons should enable
children to get in and
out easily.

Roof of vehicle is not meant
to be climbed on.

Parts needed to
assemble this toy:

12 short tubes
medium tubes

- 4 caps
- 4 elbows
- 4 axes
- 2 straight
- 2 panels
- 4 wheels
- 8 box corners
- 4 four ways
- 4 tees
- 8 panel clips
- 4 grippers