

**NEW! SERIES II**

**BATMAN®  
RETURNS**

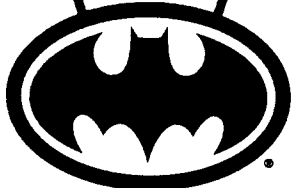

**BATMAN®**

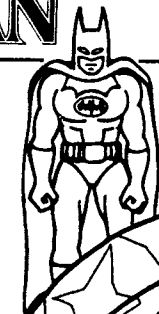

# **CAMO ATTACK BATMOBILE™**

VEHICLE

## **ASSEMBLY AND OPERATING INSTRUCTIONS**

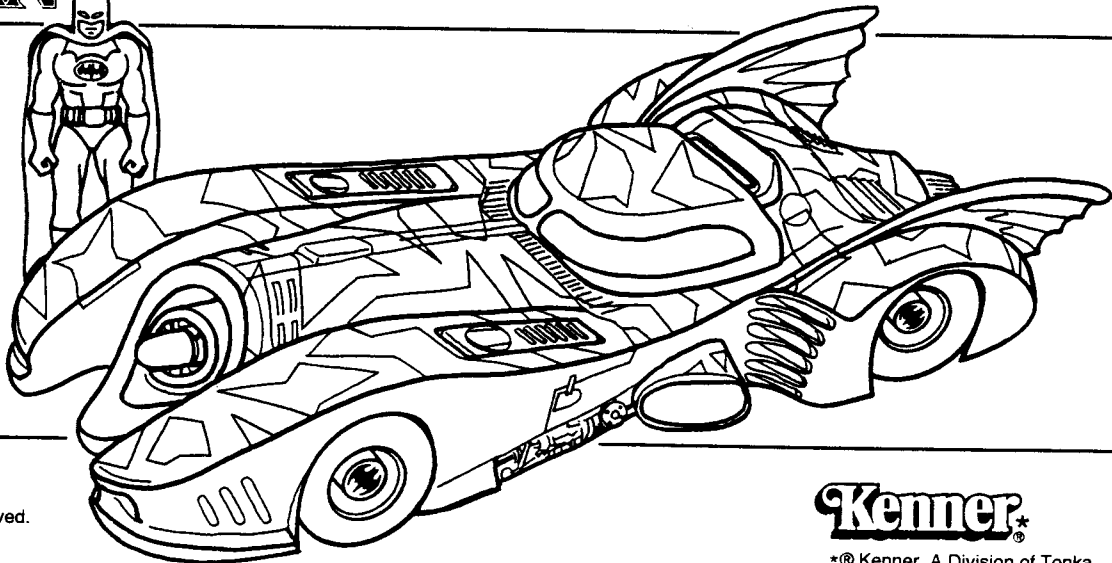

BATMAN and related elements  
are the property of DC Comics.  
TM & © 1994. All Rights Reserved.

51587400

**Kenner®**

\*© Kenner, A Division of Tonka  
Corporation, Cincinnati, Ohio 45202

# OPERATING INSTRUCTIONS

- 1.** Press Turbo Charger panel to release exhaust "Flame". As back wheels rotate "Flame" also rotates. "Flame" can be pressed back into vehicle.

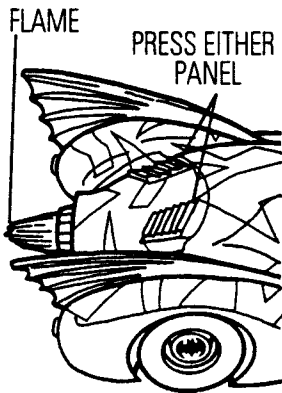

- 2.** Press down on fender panels to reveal two Fender Blasters. Press down on back of Blasters to hide them again.

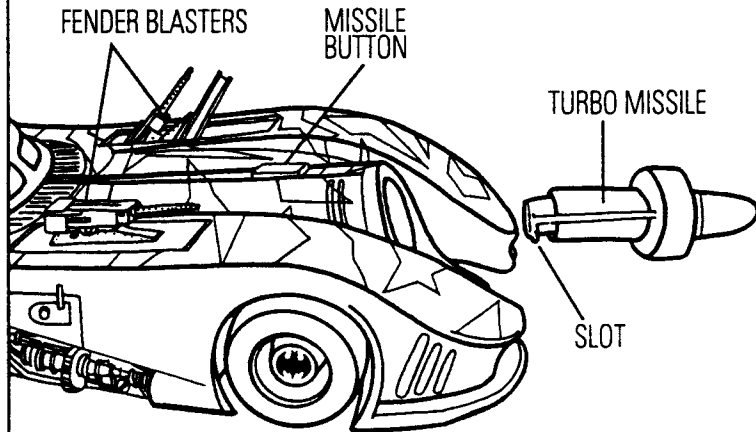

- 3.** Load Turbo Missile into position with slot turned down. Press button on hood to fire. (Caution: for play only. Do not fire toward a person's face.)

- 4.** Canopy raises and lowers to allow you to fit a Batman® figure inside.

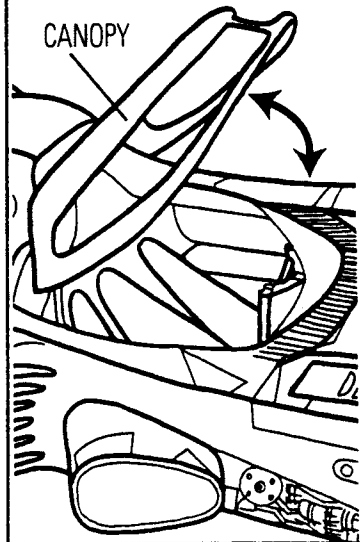

# ASSEMBLY INSTRUCTIONS

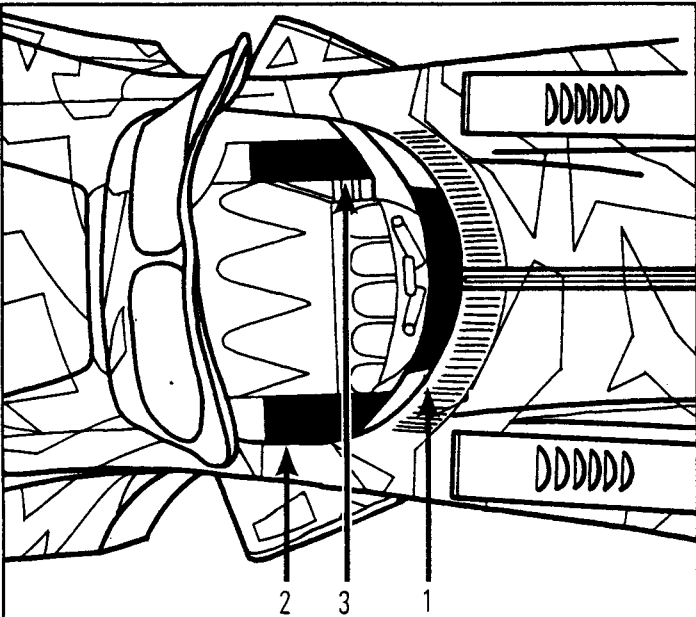

- 5.** Raise canopy and apply labels inside cockpit using numbers on label sheet and this illustration as a guide.

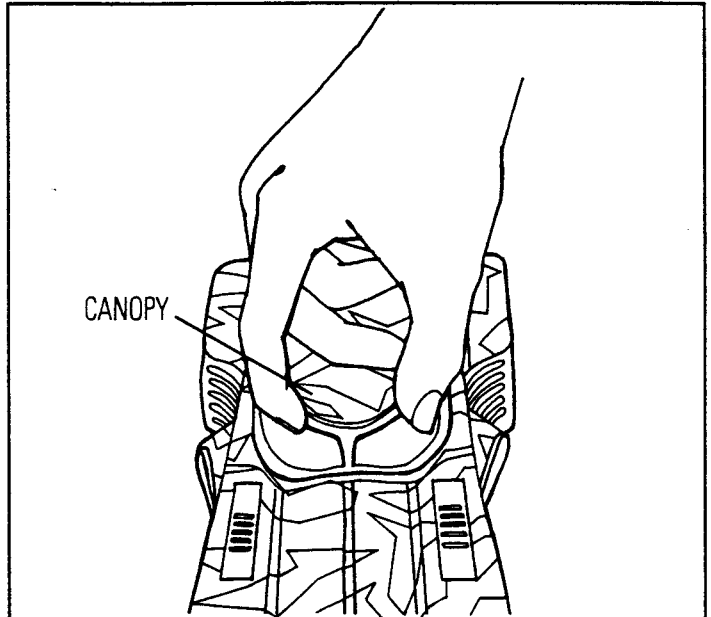

- 6.** To close canopy, push down on both side windows, as shown.

**ONE-TIME ASSEMBLY**  
Once assembled, cannot be taken apart!

- 7.** Push hub cap into the hex center of each of the four wheels.

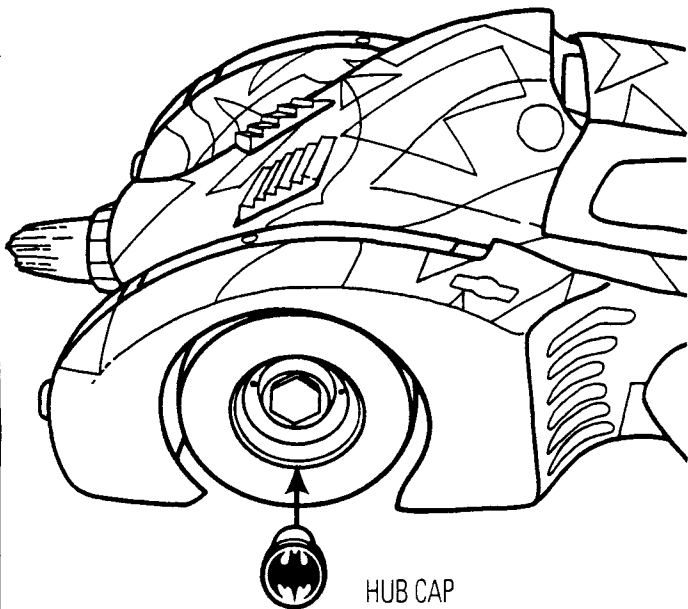

- 8.** Install the two fins by sliding front tab in first, then pressing the back pins down into place. **Note:** left and right fins have different pin location for correct placement.

