

TRANSFORMERS ANIMATED

NOTE: Some parts are made to detach if excessive force is applied and are designed to be reattached if separation occurs. Adult supervision may be necessary for younger children.



AGES 5+

83637/83501 Asst.

 **x2**
1.5V AA
R6 size
BATTERIES INCLUDED

Replace with 2 x 1.5V "AA" or R6 size batteries. Alkaline batteries recommended. Phillips/cross head screwdriver (not included) needed to replace batteries.

CHANGING TO VEHICLE

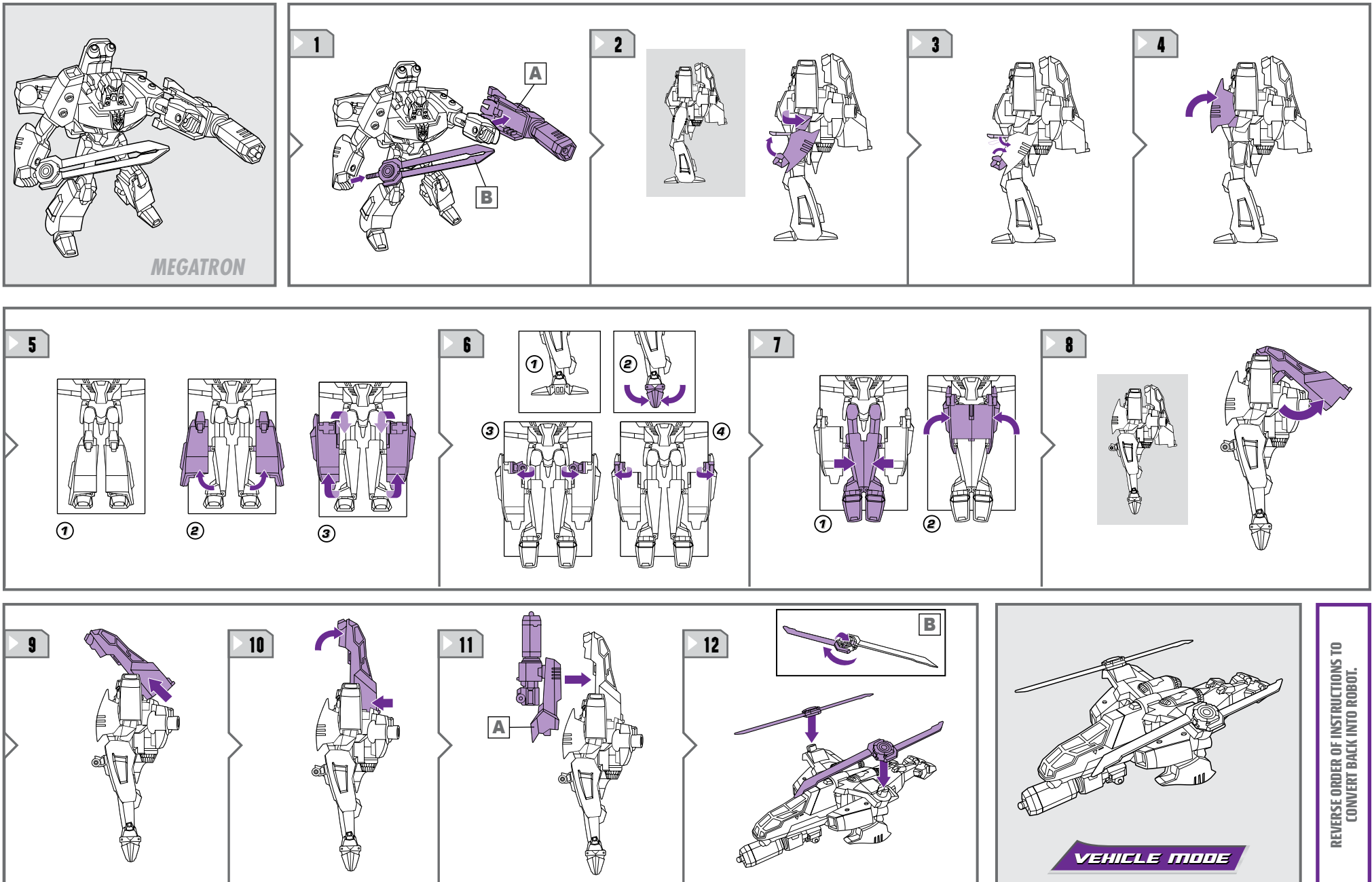

REVERSE ORDER OF INSTRUCTIONS TO CONVERT BACK INTO ROBOT.

Some poses may require hand support.

© 2008 Hasbro. All rights reserved.
TM & © denote U.S. trademarks.
Manufactured under license from Tomy Company, Ltd.



Not suitable for children under 3 years because of small parts - choking hazard.

AS SEEN ON  CARTOON NETWORK.

CARTOON NETWORK and the logo are trademarks of and © Cartoon Network.

P/N 6793670001

TRANSFORMERS.COM

To launch fusion missile:

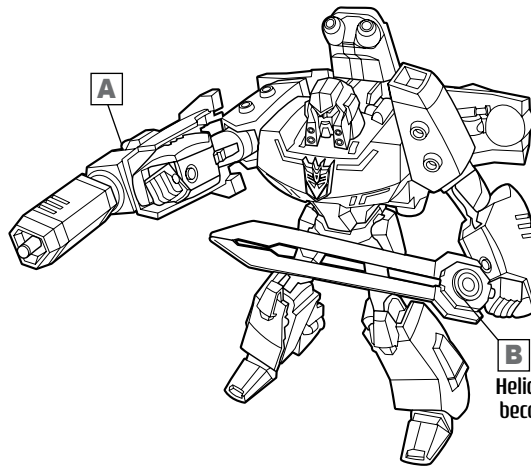
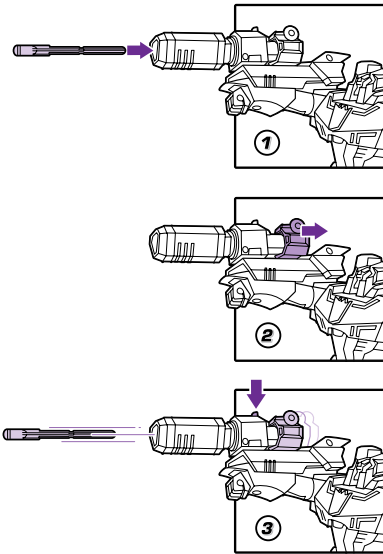

B
Helicopter blades
become swords!

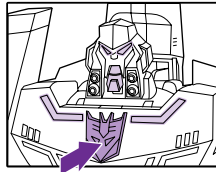
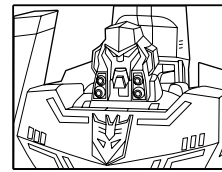

Press button for lights
and phrases!

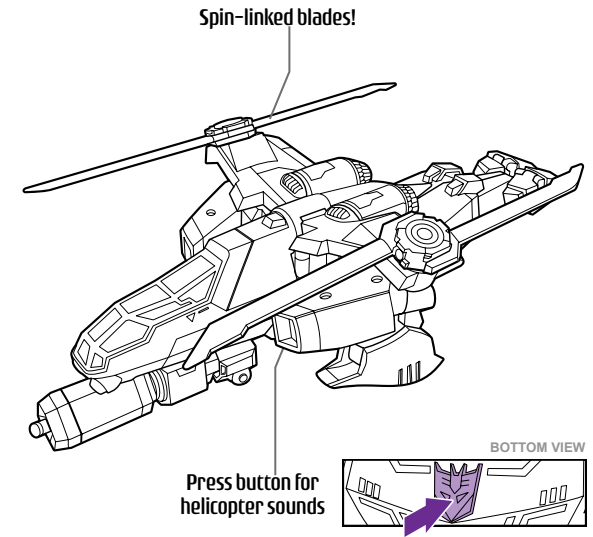

Press button for
helicopter sounds

TO REPLACE BATTERIES:

Use a Phillips/cross head screwdriver (not included) to loosen screws in caps (screws remain attached to caps). Remove battery compartment door and discard old batteries. Insert 2 x 1.5V fresh "AA" or R6 size batteries. Alkaline batteries recommended. Replace door then caps and tighten screws.

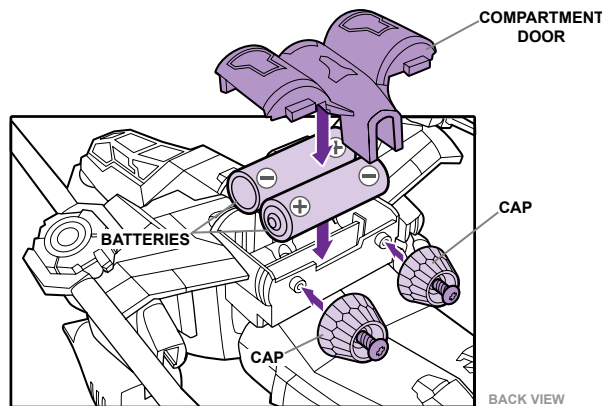

FCC STATEMENT

This device complies with part 15 of the FCC Rules. Operation is subject to the following two conditions: (1) This device may not cause harmful interference, and (2) this device must accept any interference received, including interference that may cause undesired operation. This equipment has been tested and found to comply with the limits for a Class B digital device, pursuant to part 15 of the FCC Rules. These limits are designed to provide reasonable protection against harmful interference in a residential installation. This equipment generates, uses and can radiate radio frequency energy, and, if not installed and used in accordance with the instructions, may cause harmful interference to radio communications. However, there is no guarantee that interference will not occur in a particular installation. If this equipment does cause harmful interference to radio or television reception, which can be determined by turning the equipment off and on, the user is encouraged to try to correct the interference by one or more of the following measures:

- Reorient or relocate the receiving antenna.
- Increase the separation between the equipment and receiver.
- Consult the dealer or an experienced radio/TV technician for help.

CAUTION: Changes or modifications not expressly approved by the party responsible for compliance could void the user's authority to operate the equipment.



CAUTION: TO AVOID BATTERY LEAKAGE

1. Be sure to insert the batteries correctly and always follow the toy and battery manufacturers' instructions;
2. Do not mix old batteries and new batteries or alkaline, standard (carbon-zinc) or rechargeable (nickel-cadmium) batteries;
3. Always remove weak or dead batteries from the product.

IMPORTANT: BATTERY INFORMATION

Please retain this information for future reference.

Batteries should be replaced by an adult.



CAUTION:

1. Always follow the instructions carefully. Use only batteries specified and be sure to insert them correctly by matching the + and - polarity markings.
2. Do not mix old batteries and new batteries, or standard (carbon-zinc) with alkaline batteries.
3. Remove exhausted or dead batteries from the product.
4. Remove batteries if product is not to be played with for a long time.
5. Do not short-circuit the supply terminals.
6. Should this product cause, or be affected by, local electrical interference, move it away from other electrical equipment. Reset (switching off and back on again or removing and reinserting batteries) if necessary.
7. RECHARGEABLE BATTERIES: Do not mix these with any other types of battery. Always remove from the product before recharging. Recharge batteries under adult supervision. DO NOT RECHARGE OTHER TYPES OF BATTERIES.