

Pictureka!

Flipper Game

AGES

6+



CONTENTS

1 spinning penguin, 1 iceberg top, 1 iceberg base, 16 double-sided mission tiles and 64 double-sided picture tiles.

AIM OF THE GAME

- The penguin flings tiles onto the table.
- Win the most picture tiles by finding pics that match the red or green missions.
- Keep your eyes peeled and your wits about you!

IMPORTANT: BATTERY INFORMATION

⚠ CAUTION:

1. Always follow the instructions carefully. Use only batteries specified and be sure to insert them correctly by matching the + and - polarity markings.
2. Do not mix old batteries and new batteries, or standard (carbon-zinc) with alkaline batteries.
3. Remove exhausted or dead batteries from the product.
4. Remove batteries if product is not to be played with for a long time.

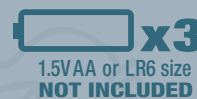

1.5VAA or LR6 size
NOT INCLUDED

ALKALINE BATTERIES REQUIRED

Phillips/cross head screwdriver (not included) needed to insert batteries.

Insert the 3 batteries as shown.

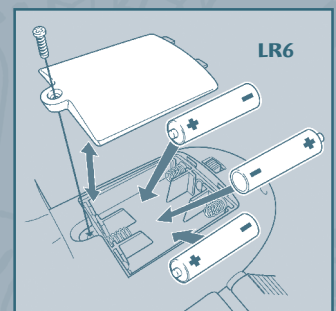

5. Do not short-circuit the supply terminals.
6. Should this product cause, or be affected by, local electrical interference, move it away from other electrical equipment. Reset (switching off and back on again or removing and re-inserting batteries) if necessary.
7. DO NOT USE RECHARGEABLE BATTERIES. DO NOT RECHARGE OTHER TYPES OF BATTERY.

Family

the find it fast,
find it first penguin game!



THE PENGUIN - Get ready to play!

Remove the rules and tiles from inside the iceberg before you put the game together.

IMPORTANT:

If the tiles get sticky, greasy or damaged, the penguin may have trouble flipping them. Wipe them down with a cloth if they get dirty and avoid bending or folding them.

Sit the penguin on top of the nobble on the iceberg.

Nobble

Put the iceberg top on top of the base.

Rules

Tiles



Important:
**NEVER OVERLOAD
THIS PENGUIN!**

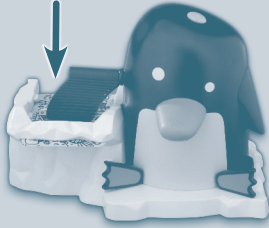

12 in.

Look for green missions when the light is green and red ones when it's red.

On/Off

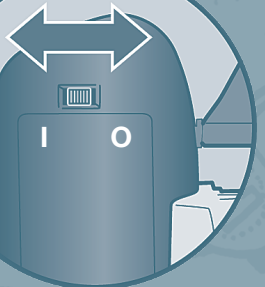

Load 48 picture tiles from the back (put 16 picture tiles to one side).



Tile tray

Mission tiles



When you're all ready to play, squeeze my beak. I'll say "Uh-oh!", then I'll flip some tiles.

Read the rules before you switch the penguin on!



THE TILES

Picture Tiles

These funky double-sided tiles are packed with pics. When you win a mission, keep the **picture tile** you found it on.



Mission Tiles

Each mission tile has two missions on it, one green and one red. What color is the light on the penguin's head flashing? That's the color mission you must find.



Watch out! When the color changes, so does the mission. The penguin warns you when he's changing color by saying 'Wat, wat!'

PLAYING

There are no turns in this part of the game so anyone can turn over mission tiles.

1. Load the flipper tray with **48 picture tiles** (count 16 tiles from the full deck and put them aside). Load the tiles by pressing down the tray and dropping the cards in on top.
2. Shuffle the mission tiles and put them next to the iceberg.
3. Everybody ready? Squeeze the penguin's beak. He'll say "Uh-oh", then the flipping frenzy starts! As he spins, he flips tiles onto the table – it's a tile tornado! Look at the tiles, but don't pick them up!
4. When the penguin stops, flip over the top mission tile, look at the flashing light on the penguin's head and read the mission that matches its color.

The penguin's light is flashing red, so look for the red mission.

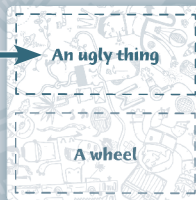

The penguin says "Wat, wat!" every time his light changes.

5. If you spot a pic that matches a mission that's the same color as the light, shout **Pictureka!**, point at the pic and say what you saw.

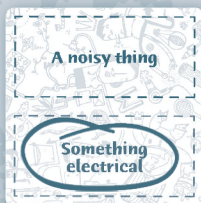

If the other players disagree, keep playing. Remember to check what color the light is flashing. If the light changes before you call **Pictureka!**, sorry, you're too slow!

If **nobody** disagrees, take the **picture tile** and keep it in front of you. Make sure you keep the tiles you've won separate from the ones in the game.

Now keep looking for other pictures that match that mission!

6. When the light changes, read that color mission and start hunting for pics again.
7. Once you've used both the missions on one side of the tile, flip it over and use the other side. Take a new mission tile when you've used up both sides.
8. When the penguin starts flipping again, stop playing and take a break while he churns out some new picture tiles.
9. As soon as he stops, flip over a new mission tile and read the mission that matches the color of the penguin's flashing light.

Tip: If everyone's stuck, discard the tricky mission tile and flip over a new one.



Ending the Game

10. Keep playing until the penguin blows a raspberry (or you run out of picture tiles). The player with the most picture tiles wins the game!

Mission-Masher Top-up Game

Aim of the Game

To win the most **mission tiles** by searching the picture tiles you won.

Once you're Flipper experts, you can add this extra mission game on the end.

1. When the game is over, put the penguin to one side and clear away any unclaimed picture tiles.
2. Count the picture tiles you've won, then spread out your own tiles in front of you.

Note: If any player has less than 2 picture tiles, **all players** take 2 extra picture tiles each from the ones you cleared away.

3. Shuffle the mission tiles and put them in a pile in the center and agree what color missions to play.
4. The player with the most picture tiles turns over the top tile and reads that color mission.
5. Quick as you can, search your own tiles for a picture that matches that mission. As soon as you find one, shout **Pictureka!**, point at it and be ready to say why it matches.
6. If everyone agrees, you keep the **mission tile** you found the pic on.

Rules for Mission-Mashing

- If you shouted and others disagree, keep looking.
- If you shouted and you weren't even close to having a pic to point out, you're a sneaky cheat. Lose a picture tile.

Note: If you're down to 1 picture tile, you can keep it!

7. The player to the left of the last reader now reads the next mission of the agreed color.
8. Keep playing until you run out of mission tiles.

Note: If everyone is stuck on a mission, flip the tile.

Ending the Game

9. The player with the most mission tiles is the winner.



Tile Tornado Tips

- Each time he spins, the penguin flings out up to 12 tiles. He's a fickle bird, so don't worry if he doesn't flip them all, or if there are stragglers left when the game is over.
- If you've used up all the picture tiles before the penguin has finished his break, just squeeze his beak to nudge him back into action.
- Even when the penguin has finished flipping, the game's not over till he blows a raspberry (or you run out of picture tiles).
- The penguin goes to sleep as soon as he's finished flipping. Just squeeze his beak to wake him up. Shuffle the picture tiles and load a new set of 48 tiles.

Team Play

Feel free to split into teams to help younger players.

STORAGE

Fold the rules carefully and slide them underneath the tile trays in the iceberg. Now drop half the tiles into each tray.

Put the iceberg and penguin back together and leave him out where he can keep an eye on things.

Remember:

Always switch off your penguin!

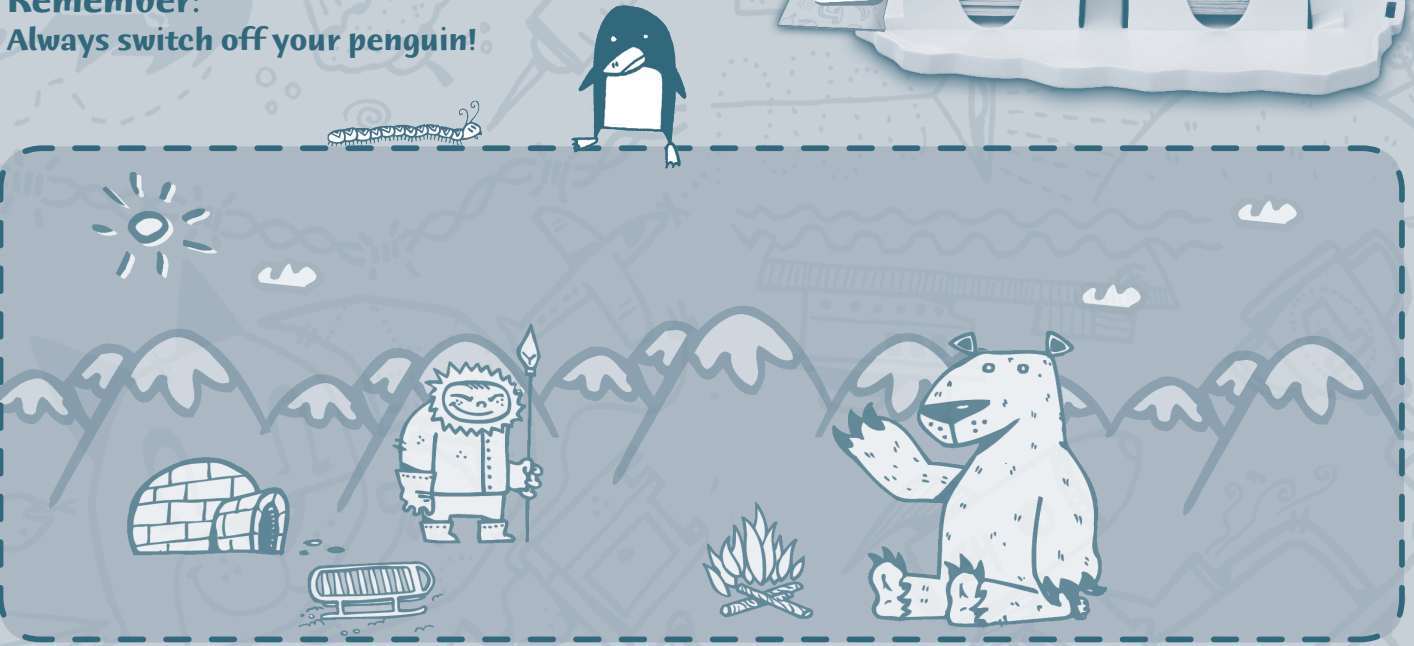

FCC Statement

This equipment has been tested and found to comply with the limits for a Class B digital device, pursuant to part 15 of the FCC Rules. These limits are designed to provide reasonable protection against harmful interference in a residential installation. This equipment generates, uses, and can radiate radio frequency energy, and, if not installed and used in accordance with the instructions, may cause harmful interference to radio communications. However, there is no guarantee that interference will not occur in a particular installation. If this equipment does cause harmful interference to radio or television reception, which can be determined by turning the equipment off and on, the user is encouraged to try to correct the interference by one or more of the following measures:

Reorient or relocate the receiving antenna.

Increase the separation between the equipment and receiver.

CAUTION: Changes or modifications not expressly approved by the party responsible for compliance could void the user's authority to operate the equipment.

This Class B digital apparatus complies with Canadian ICES-003.

Cet appareil numérique de la classe B est conforme à la norme NMB-003 du Canada.



European Consumers: This product and its batteries must be disposed of separately at your local waste recycling centre.

Do not dispose of them in a household waste bin.

Licensed by Arne Lauwers. Art by Eugene and Louise.

© 2008 Hasbro, Pawtucket, RI 02862. All Rights Reserved. TM & ® denote U.S. Trademarks. Patents Pending.

We will be happy to hear your questions or comments about this game.

Please write to: Hasbro Games, Consumer Affairs Dept., P.O. Box 200, Pawtucket, RI 02862.

Tel: 888-836-7025 (toll free).

European consumers please write to: Hasbro UK Ltd., Hasbro Consumer Affairs, P.O. BOX 43, Caswell Way, Newport, Wales, NP19 4YD, or telephone our helpline on 00 800 2242 7276

MADE IN CHINA

PROOF OF PURCHASE



89857

hasbrogames.com

