

The background of the page is a grayscale illustration of a theme park. In the foreground, a roller coaster track winds through the scene. In the background, a large Ferris wheel is visible against a sky with some clouds. The overall scene is detailed, showing various park structures and landscaping.

RollerCoaster

TYCOON[®] Board Game

For 2 to 4 Players • Ages 8 & Up

Object

Buy attractions and move the guests throughout the park. The more guests you get onto attractions the more guest points you collect. Be the player with the most guest points at the end of the game and you win!

Contents

1 6-sided Die • 1 8-sided Die • 29 Attraction Cards • 54 Event Cards
• 12 \$1,000,000-bills • 12 \$500,000-bills • 40 \$100,000-bills • 26 Attraction
Markers • 7 Guest Tokens (seven different colors) • 104 Player Pieces (26 each
of red, yellow, blue, purple) • 43 1-point Guest Chips • 22 5-point Guest
Chips • 10 10-point Guest Chips • 6 20-point Guest Chips • 2 Closed Signs
• 4 Mechanic Tokens • 4 Handyman Tokens • Month Marker • 10 Plastic
Pawn Stands • Wooden Roller Coaster Assembly (plastic base/3-piece
cardboard ride) • Steel Roller Coaster Assembly (plastic base/4-piece
cardboard ride) • Whoa Belly Assembly (plastic base/2-piece cardboard ride)
• Label Sheet • Gameboard

First Time Setup

- Place the labels from the label sheet onto the 8-sided die.
- Carefully punch out all of the cardboard pieces from the parts sheet. Discard the cardboard waste.
- Assemble the 2 Roller Coasters and the Whoa Belly as shown on pages 2 and 3. Set these off to the side for now. You'll need them in a little while.

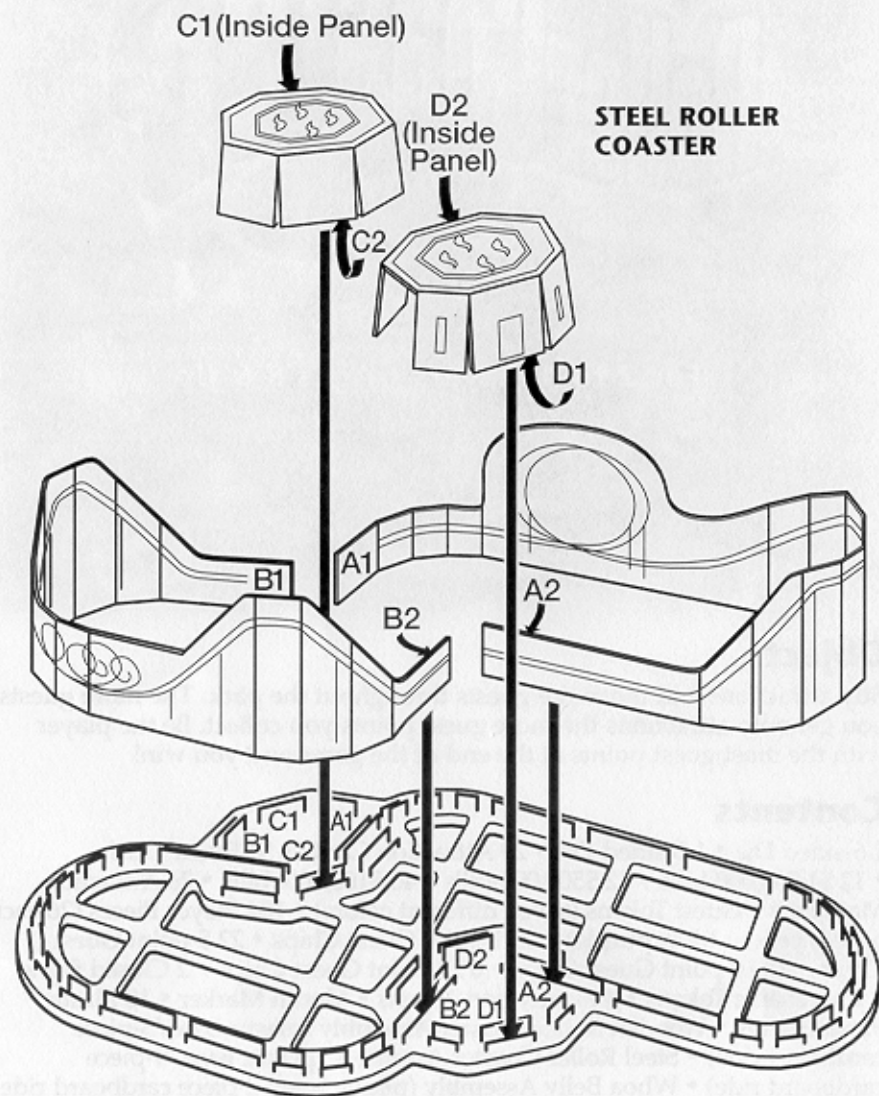

2

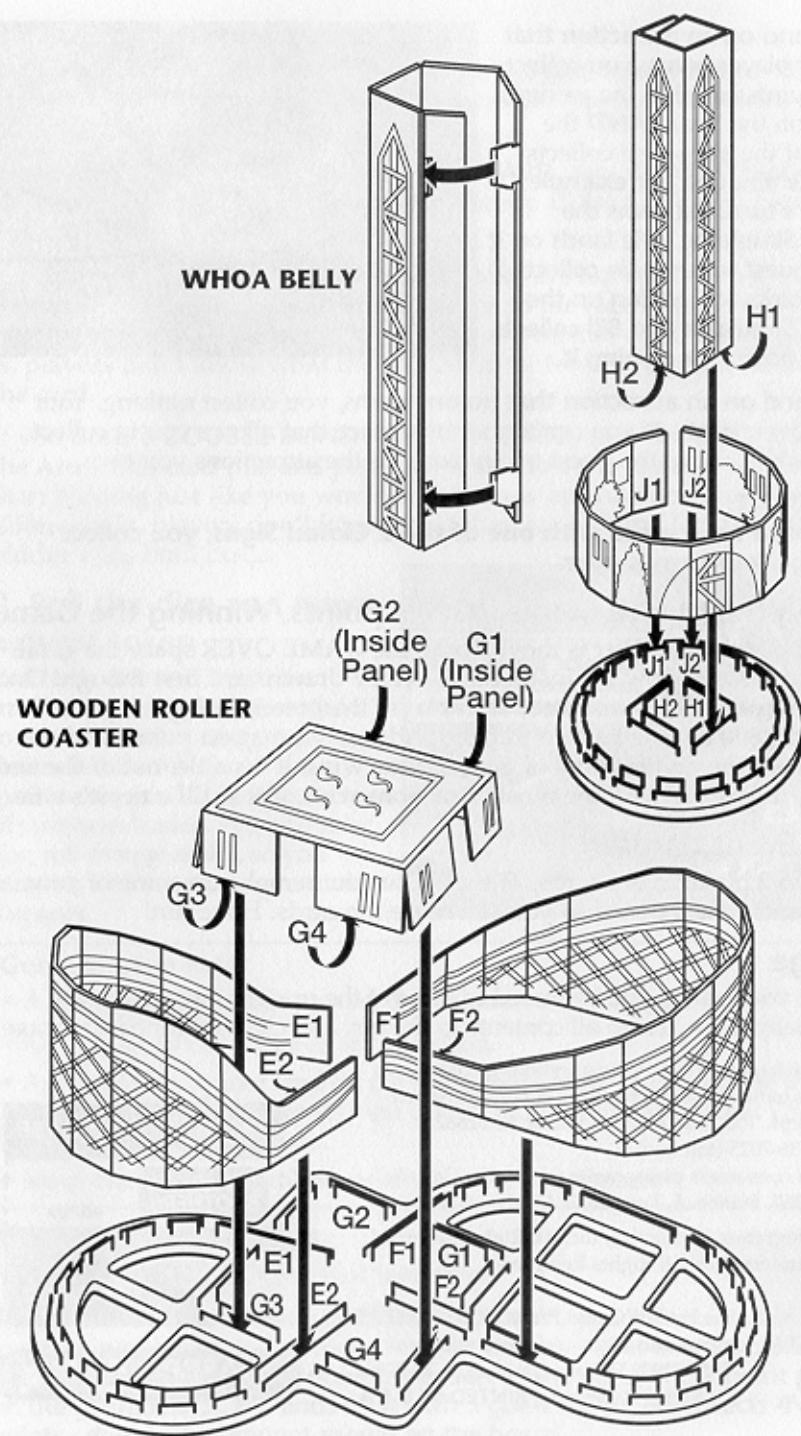

3

- Insert the 2 Closed Signs and the Month Marker into the clear pawn stands. Then insert each of the 7 guest tokens into the pawn stands that match in color.
- Remove the 2 blank Event cards from the Event deck. Set the blank cards aside for now. We'll explain them a little later.
- Remove the 1 blank Attraction card from the Attraction deck and set it back in the box. You don't use this one in play but you can keep it as a spare.

Every Time Setup

Place 1 Closed Sign on the River Rapids space, the other Closed Sign on Wooden Roller Coaster space, the Month Marker on MAR YEAR 1, and the 7 guest tokens on the Park Entrance space. See Figure 1.

FIGURE 1

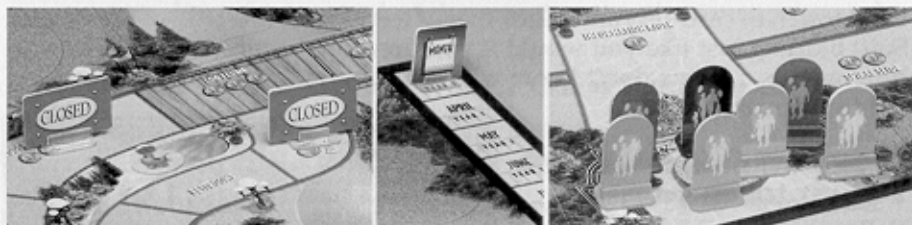

Pick one player to be the banker. The banker then gives each player 2 \$1,000,000-bills, 1 \$500,000-bill and 5 \$100,000-bills. If the banker is also a player, he/she must keep his/her money separate from the bank's.

Each player picks a color (red, blue, yellow or purple) and takes the matching cardboard pieces. These are the player pieces and will be used to identify who owns which rides.

Shuffle the Event cards and place them facedown in the center of the gameboard. Leave room for a discard pile.

Place all of the attraction markers facedown (with the name of the attraction facing up) next to the corresponding attraction space on the gameboard. **NOTE:** The Wooden Roller Coaster, Steel Roller Coaster and Whoa Belly do not have attraction markers. When these rides are purchased, place the cardboard ride assembly onto the board inside the ride's outline. See Figure 2.

FIGURE 2

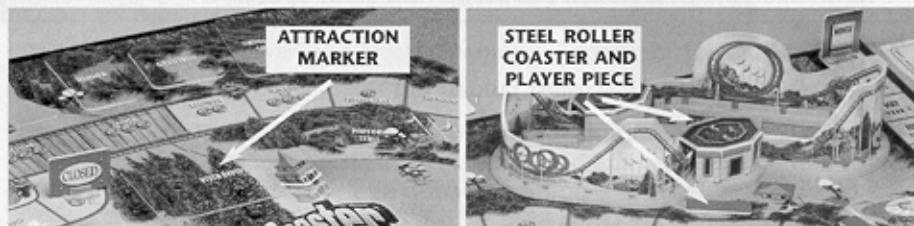

Shuffle the Attraction cards and deal out 2 to each player. Set the remaining cards in a pile facedown, off to one side of the gameboard.

Place your Attraction cards faceup in front of you. Then, turn the attraction markers corresponding to your cards faceup and pay the bank the starting fees for both. Now place one of your player pieces in the rectangular space next to your attraction to show that you own it (refer to Figure 2). **REMEMBER:** The Wooden Roller Coaster, Steel Roller Coaster, or Whoa Belly, have no attraction markers. If you were dealt any of these 3 rides, place its assembly at its location on the gameboard.

Each player must then decide whether or not to hire maintenance staff to repair or inspect his/her attractions. You can only hire maintenance staff at the beginning of the game; never during. You may hire a staff of Mechanics, a staff of Handymen, both, or neither. You cannot hire 2 staffs of the same. The price for each varies depending on how many players are in the game:

- 2 players - Mechanics (\$400,000), Handymen (\$400,000)
- 3 players - Mechanics (\$300,000), Handymen (\$300,000)
- 4 players - Mechanics (\$200,000), Handymen (\$200,000)



HANDYMAN



MECHANIC

If you choose to hire maintenance staff, pay the bank the fee(s) and take the corresponding token(s). Place the token(s) in front of you showing the picture of the Mechanic and/or Handyman. **IMPORTANT NOTE:** During the game, you may draw an Event card showing a Mechanic or Handyman. If you draw one of these cards and didn't hire the maintenance staff shown, you will have to pay the bank \$200,000 to bring someone in to do the job. If you don't have the money to pay the bank, you'll have to give up 2 guest points per maintenance staff drawn.

THIS GAME IS SET UP FOR 4 PLAYERS.

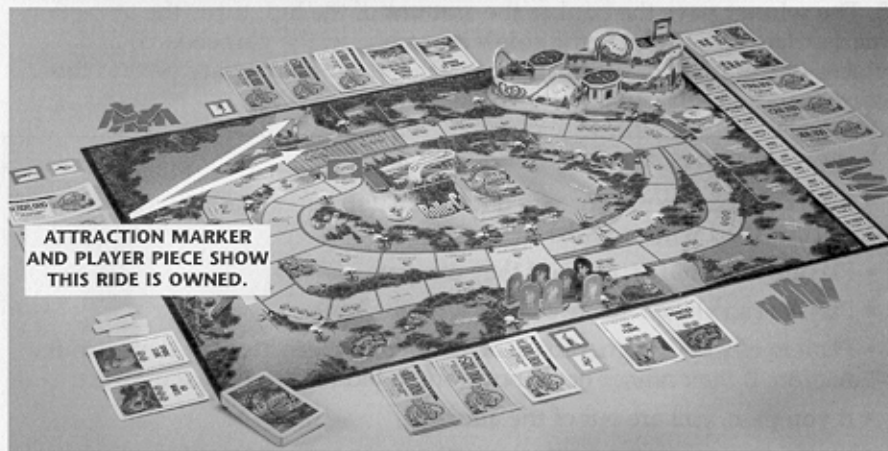

ATTRACTION MARKER AND PLAYER PIECE SHOW THIS RIDE IS OWNED.

Gameplay

Roll the 6-sided die. The person rolling the lowest goes first. If there is a tie for the lowest roll, the tied players re-roll. Play then passes to the left.

On your turn

1. Draw an Event card and follow its instructions immediately.
2. Roll the dice and move a guest token.
3. Award guest points.

1. Draw an Event card and follow its instructions

Draw an Event card and place it faceup next to the draw pile. This is the discard pile. Some of the cards will send guests throughout the park, some will award money, some will advance the Month Marker and some will put attractions up for auction. Follow the instructions on the card. If you flipped over an "Auction" card, see **Auction Cards** below.

Auction Cards

If you draw an Auction card an auction follows. Here's how an auction works:

1. Flip over the top Attraction card(s) and place it on the side of the board.
2. The player drawing the Auction card starts the bidding by announcing how much he/she is willing to pay in order to own the attraction. NOTE: The player may choose to pass (bid nothing) if he/she does not want the attraction.
3. Bidding then passes to the left with players either raising the bid or passing. NOTE: You must bid higher than the bid before you to stay in the auction.
4. Continue bidding until all but one player passes. This person has "won the bid."
5. The winner pays the banker the amount of the bid, turns the attraction marker faceup (or places the ride's assembly on the gameboard) and places one of his/her player pieces in the rectangular space next to the corresponding attraction.

Important Notes about Bidding

- If no one bids on the auctioned attraction(s), the player who drew the Auction card wins it for free.
- Players must bid an amount they can pay.
- Players can always make change with the bank.
- Players must bid higher than the bid before them in order to stay in the auction. If they cannot or do not want to bid higher, they must pass.
- If you pass, you are out of the auction.

Types of Auctions

If you draw an **AUCTION CARD**, take the top card from the Attraction card pile and place it faceup to the side of the board. The highest bidder wins this card.

If you draw a **DOUBLE OPEN AUCTION CARD**, take the top 2 cards from the Attraction card pile and place them faceup to the side of the board. The highest bidder wins both cards.

If you draw a **BLIND AUCTION CARD**, take the top card from the Attraction card pile and place it facedown to the side of the board. Start bidding just like you would if you drew an Auction card. The difference is, players don't know what they are bidding for. The highest bidder wins the card.

If you draw a **DOUBLE BLIND AUCTION CARD**, take the top 2 cards from the Attraction card pile and place them facedown to the side of the board. Start bidding just like you would if you drew an Auction card. The difference is, players don't know what they are bidding for. The highest bidder wins both cards.

2. Roll the dice and move a guest token

Roll both dice and move the matching color guest token the indicated number of spaces. If you rolled the Wild, move any guest token you'd like, the number of spaces indicated. For example: You roll orange and 3, so you must move the orange guest token 3 spaces.



Guest Moving Rules

- A guest token must be moved the full amount of the roll.
- A guest token can move in any direction.
- A guest token cannot land on the same space more than one time in a single move. In other words, you cannot move onto a space that you already occupied this turn.
- More than one guest token can occupy the same space.

3. Award guest points

Now look at the space the guest landed on!

If you land on an attraction space that you own, you collect double the guest points shown on the board for that attraction. For example: Bill owns the Motion Simulator (a 2-point attraction as shown by the 2-point marks on the gameboard). He lands on it with a guest token. Bill collects 4 guest points - double the amount shown on the board.

If you land on an attraction that another player owns, you collect guest points equal to the amount shown on the board AND the owner of the attraction collects the same amount. For example: It's Julie's turn. Bill owns the Motion Simulator. Julie lands on it with a guest token. Julie collects 2 guest points for landing on the Motion Simulator and Bill collects 2 guest points for owning it.

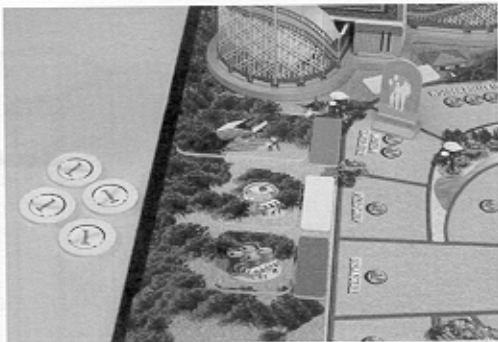

If you land on an attraction that no one owns, you collect nothing. Your turn is over. **Hint** - If you can't land on a space that allows you to collect guest points, move the guest token closer to the attractions you own.

IMPORTANT:

If you land on a space with one of the 2 Closed Signs, you collect nothing. Your turn is over.

Moving the Month Marker/Guest points/Winning the Game

When the Month Marker is moved onto the GAME OVER space the game ends. You must follow the instructions on the drawn card first though! Once the last drawn card is resolved, each player then receives 1 guest point for each \$100,000 he/she has left in hand. Add up your guest points and the player with the highest total of guest points wins. If it's a tie, out of the tied players, the player with the most attractions wins. If it's still a tie, it's a tie.

Blank Event Cards

There are 2 blank Event cards. These allow you to make up some of your own events. Use a pencil so you can reuse the cards. Have fun!

Storage

To store your game, you will need to remove the upright tower from the Whoa Belly. Then return all contents to the box and close lid for easy storage.

We will be happy to hear your questions or comments about this game. Write to: Hasbro Games, Consumer Affairs Dept., P.O. Box 200, Pawtucket, RI 02862. Tel: 888-836-7025 (toll free).

Canadian consumers please write to: Hasbro Canada, P.O. Box 267, Station A, Longueuil, Quebec J4H 3X6.

©2002 Infogrames Interactive, Inc. All Rights Reserved.

©2002 Chris Sawyer. All Rights Reserved.



The HASBRO and PARKER BROTHERS names and logos and these rules are
® & ©2002 Hasbro, Pawtucket, RI 02862.
All Rights Reserved. PRINTED IN U.S.A.

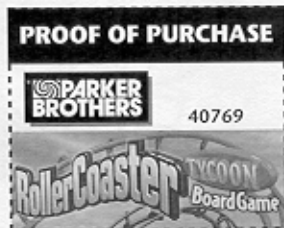

HASBRO.COM
FOR NEW PRODUCTS AND OFFERS