

BEYBLADE™

HIGH PERFORMANCE TOPS

Zinrai™

With hidden dragon action figure ZINRAI™

AGES 8+
82555/82528 Asst.

45

⚠ WARNING: Do not use BEYBLADE tops or Beystadium™ on tables or other elevated surfaces.

BEYBLADE tops/BEYSTADIUM are intended to be used on the floor. Do not lean over the stadium when BEYBLADE tops are in play. BEYBLADE tops may bounce up and hit eye or face.

Includes unassembled BEYBLADE top, launcher, ripcord and instructions.

Assembly required.
Phillips screwdriver needed (not included).

- Before assembly and playing, please read instructions. Please keep these instructions for future reference.
- When removing parts from runner frame, ask an adult to help you trim off any excess plastic using scissors or other suitable tool.
- The frame is numbered. Please follow the numbers carefully and make sure you are assembling the right parts.
- Discard plastic bags immediately.

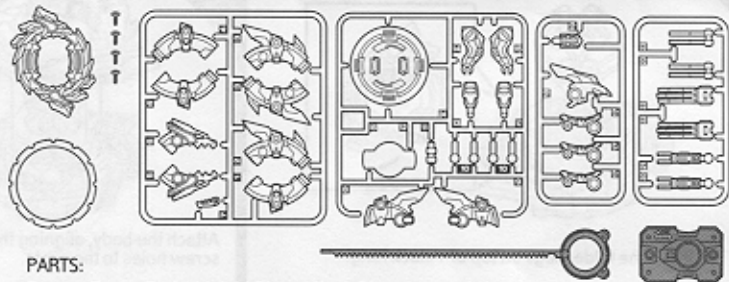

PARTS:
Runner Frame Parts, Weight Ring, Attack Ring, Screws (4),
Right-Spin Launcher, Ripcord

BUILD DRAGON:

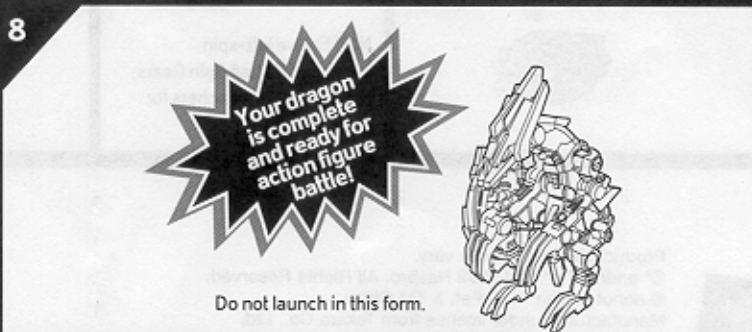
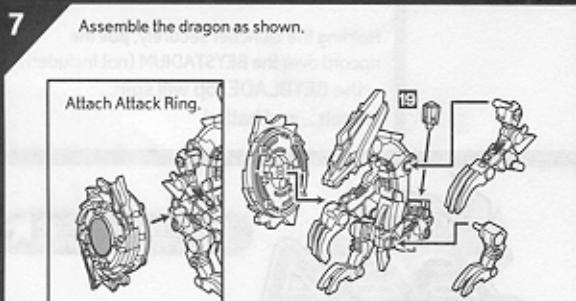
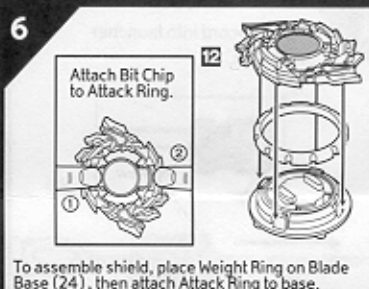
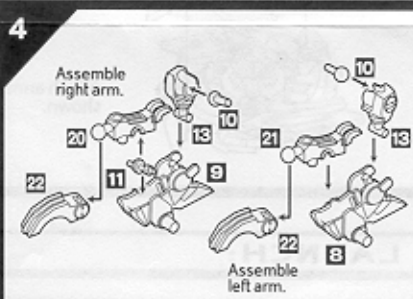
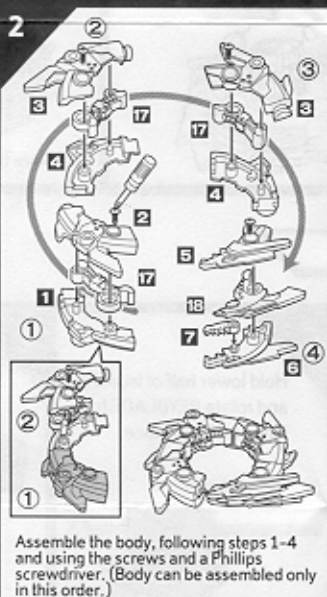
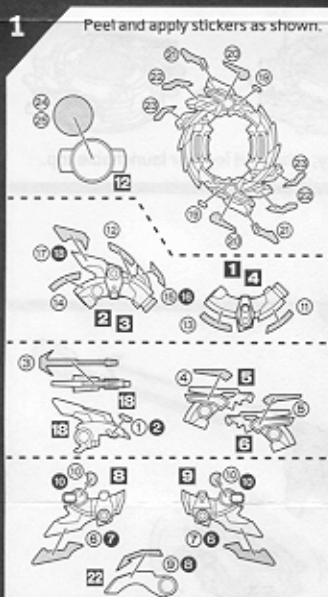

CHANGE TO HIDDEN SPIRIT:

1

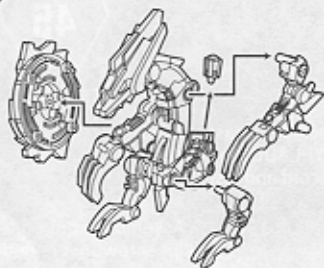

Remove shield, arms, legs and tail. Twist body into a circle.



2

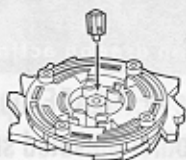

Insert tail into Blade Base.

3

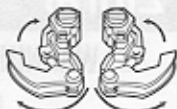

Fold in leg claws as shown.

4

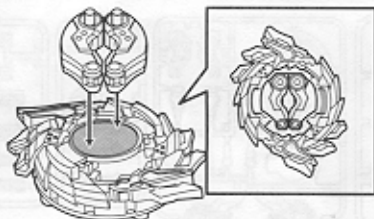

Place the folded legs on top of Attack Ring.

5



Attach the body, aligning the 4 screw holes to the posts.

6

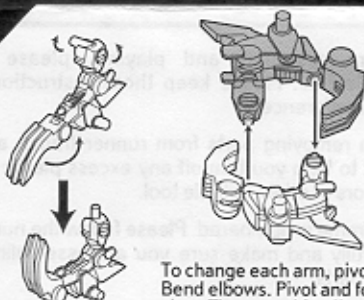

To change each arm, pivot axle up. Bend elbows. Pivot and fold in claw. Then, combine the arms.

7

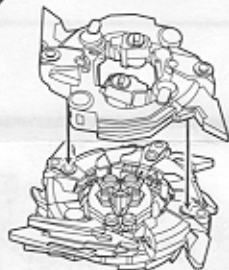

Attach arms as shown.

8



Do not launch in this form.

9

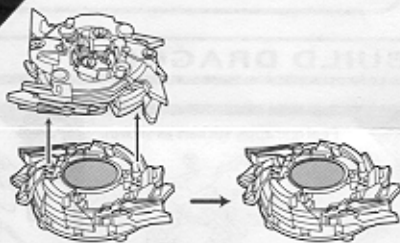

Remove body, arms and legs for launchable top.

LAUNCH:

A

Insert ripcord into launcher as shown.

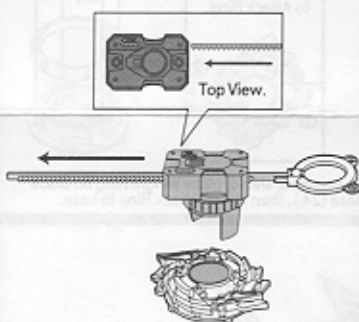

B

Insert posts on launcher into openings in BEYBLADE top, as shown.

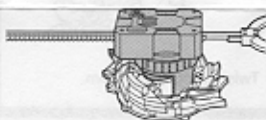

NOTE: Use left-spin launchers for Left Spin Gears; use right-spin launchers for Right Spin Gears.

C

Hold lower half of launcher and rotate BEYBLADE top left to lock it in place.

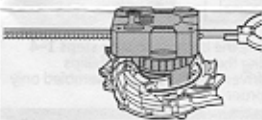

D

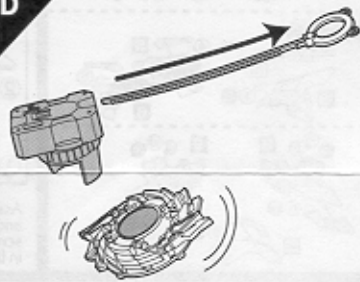

Holding the launcher securely, pull the ripcord over the BEYSTADIUM (not included) – the BEYBLADE top will spin... launch... and battle!

Product and colors may vary.

® and/or TM* & © 2002 Hasbro. All Rights Reserved.

© denotes Reg. U.S. Pat. & TM Office.

Manufactured under license from Takara Co., Ltd.

©HUDSON SOFT/TAKARA-BEYBLADE PROJECT-TV TOKYO. All Rights Reserved.



BEYBLADE.HASBRO.COM
FOR NEW PRODUCTS AND OFFERS

P/N 618152000