

1313 Dead End Drive™

GAME

Ages 8 and Up
2 to 4 Players

CONTENTS

- 3D Mansion gameboard with 3 back walls and 5 traps: Stairs, Fireplace, Boar's Head, Safe and Suit of Armor
- 16 Heir pawns with stands
- Deck of 48 cards (16 Heir cards and 32 Playing cards)
- Aunt Agatha's Will
- 20 Moneybag tokens
- 2 Black dice
- 4 Plastic back wall clips
- Label sheet

Figure 1 shows a game assembled and set up for 4 players. Refer to it as you assemble and set up your own game.

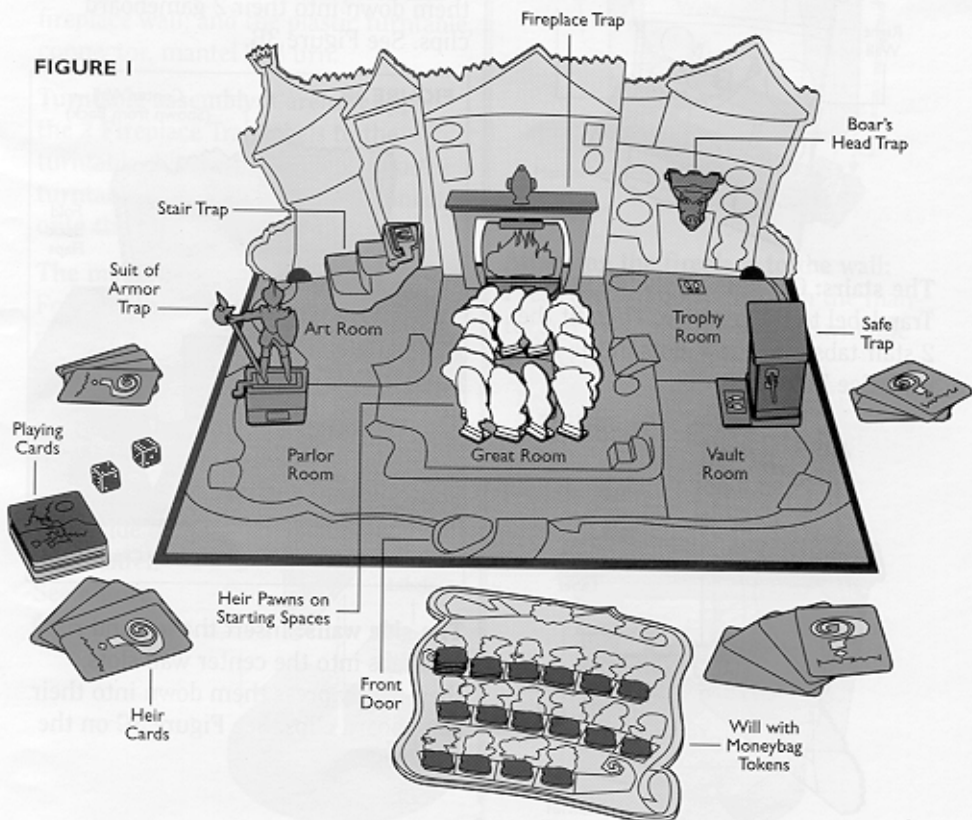

ASSEMBLY

Remove the plastic parts from their bags, and discard the bags. Remove each cardboard part from its parts sheet as it is needed. Discard the waste.

ATTACH THE SHIELD AND STAIRS TO THE BACK WALLS

You'll need: The left and right back walls; the plastic Boar's Head shield; and the plastic stairs.

The shield: Fit the shield tabs into the slots in the right wall as shown in Figure 2A.

FIGURE 2A

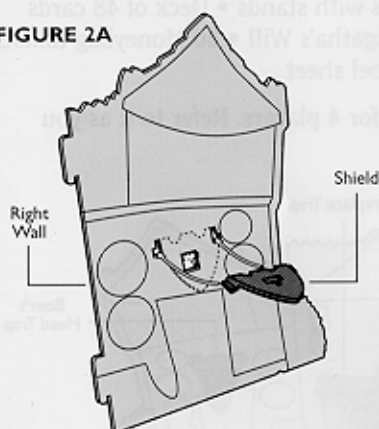

The stairs: Carefully apply the Stair Trap label to the top step. Then fit the 2 stair tabs into the 2 slots in the left wall. See Figure 2B.

FIGURE 2B

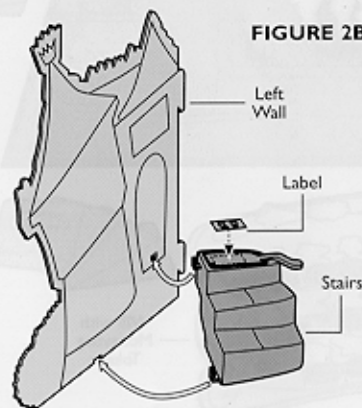

ATTACH THE WALLS TO THE GAMEBOARD

You'll need: The gameboard; the 4 black plastic clips; and the right, left and center back walls.

The clips: Turn the gameboard upside down. Push a plastic clip through each of the 4 gameboard holes. See Figure 3A. Then turn the gameboard rightside up and place it on a flat surface.

FIGURE 3A

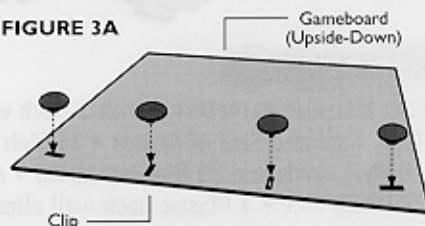

The center wall: Fold the side flaps along the score lines. Then gently press them down into their 2 gameboard clips. See Figure 3B.

FIGURE 3B

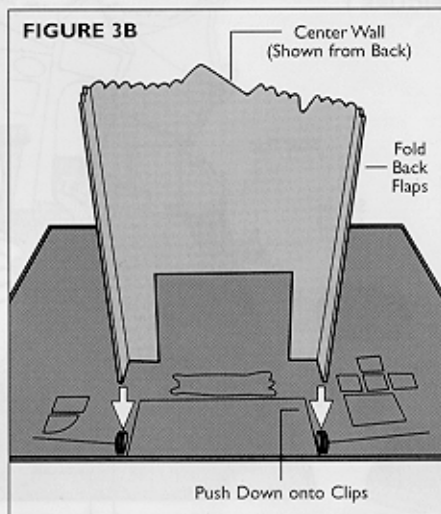

The side walls: Insert the left and right wall tabs into the center wall slots, then gently press them down into their gameboard clips. See Figure 3C on the next page.

FIGURE 3C

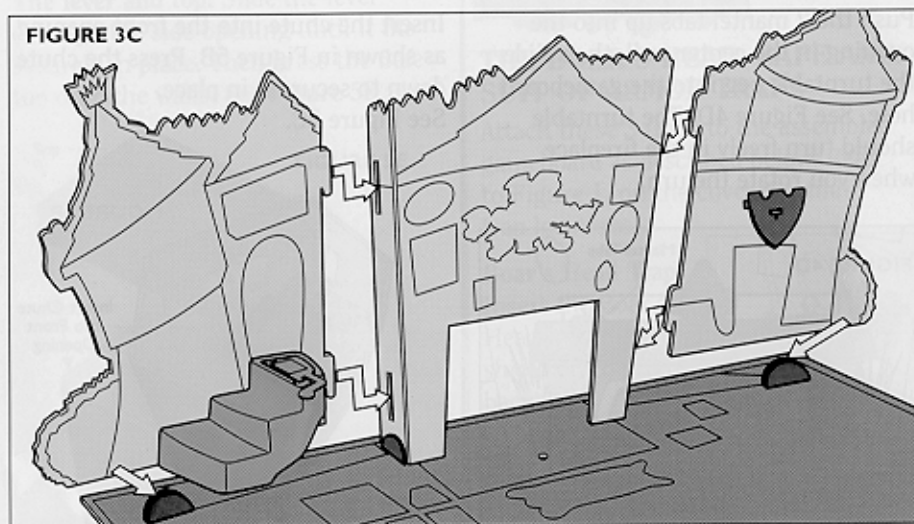

ASSEMBLE AND ATTACH THE FIREPLACE TRAP

You'll need: The 2 Fireplace Trap labels; the cardboard flame piece and fireplace wall; and the plastic turntable connector, mantel and urn.

Turntable assembly: Carefully apply the 2 Fireplace Trap labels to the turntable. Fit the flame piece into the turntable slot, then slide the connector onto the top. See Figure 4A.

The mantel: Fold the fireplace wall along the score lines. Then slide the folded wall into the underside of the mantel. See Figure 4B.

FIGURE 4A

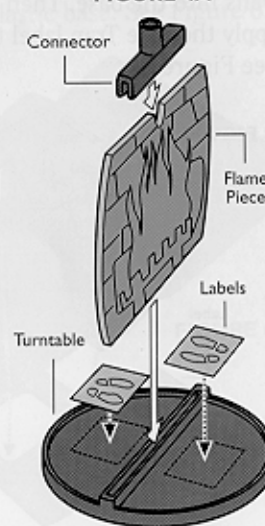
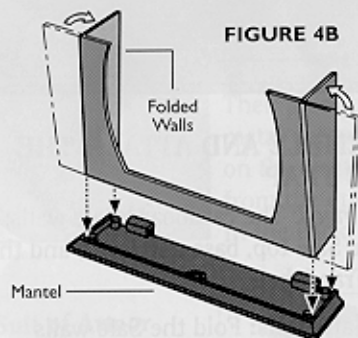
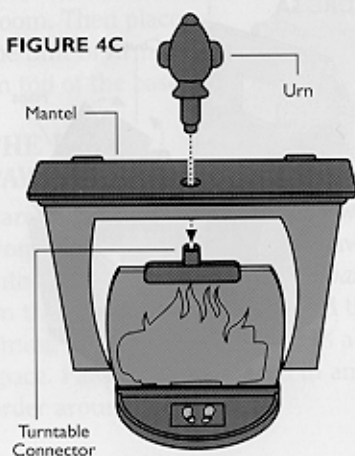

FIGURE 4B



Attaching the fireplace to the wall: Press the urn down through the mantel and into the hole in the turntable connector. See Figure 4C.

FIGURE 4C



Push the 2 mantel tabs up into the opening in the center wall, then slide the turntable peg into the gameboard hole. See Figure 4D. The turntable should turn freely in the fireplace when you rotate the urn.

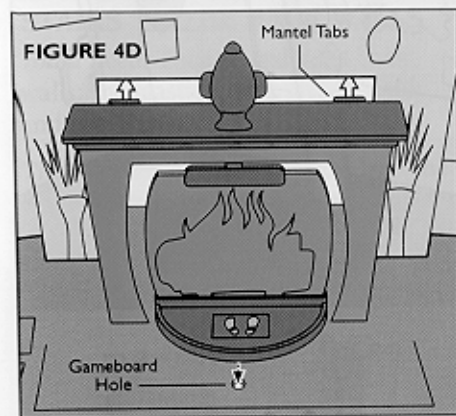

ASSEMBLE AND ATTACH THE SAFE TRAP

You'll need: The cardboard Safe walls; plastic Safe top, base and lever; and the Safe Trap label.

The Safe walls: Fold the Safe walls along their score lines. Carefully fold the chute backward along the score line. Then fold the chute flaps up. See Figure 5A.

FIGURE 5A

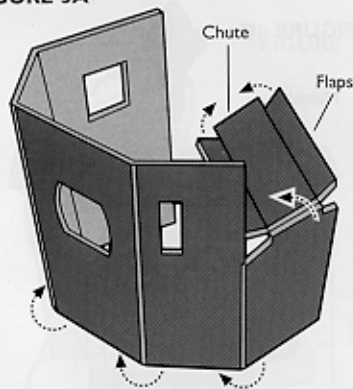

Insert the chute into the front opening, as shown in Figure 5B. Press the chute down to secure it in place. See Figure 5C.

FIGURE 5B

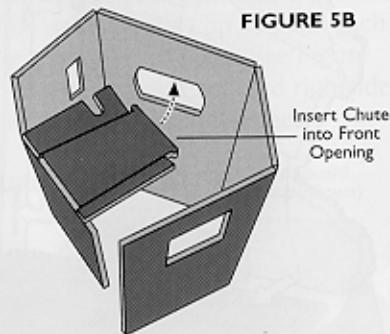
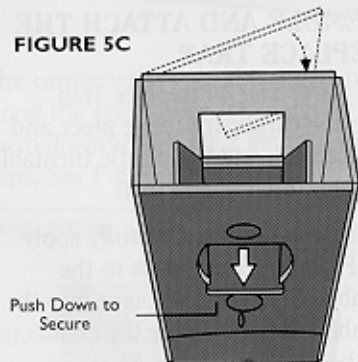
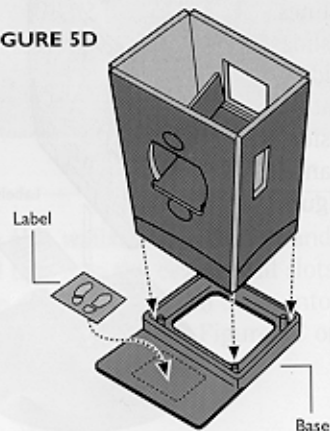

FIGURE 5C



The label and base: Press the safe walls into the base. Then carefully apply the Safe Trap label to the base. See Figure 5D.

FIGURE 5D



The lever and top: Slide the lever through the side opening until it fits securely in place. Then press the Safe top onto the walls. See Figure 5E.

FIGURE 5E

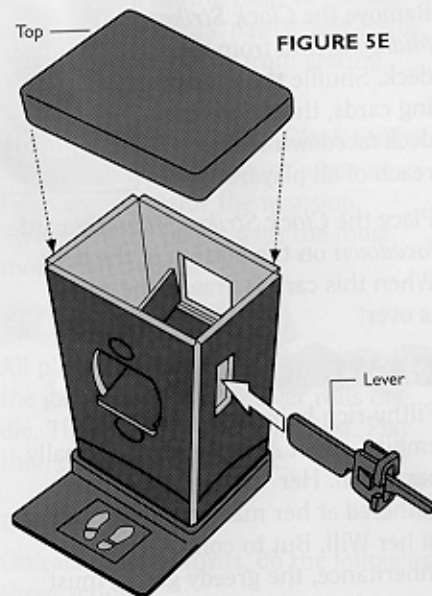

LABEL THE SUIT OF ARMOR TRAP

You'll need: The Suit of Armor Trap label and the plastic Suit of Armor base.

Carefully apply the Suit of Armor Trap label to the plastic base. See Figure 6.

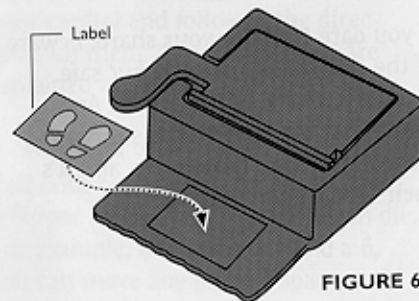

FIGURE 6

GAME SETUP

THE BOAR'S HEAD, SAFE AND SUIT OF ARMOR TRAPS

Attach these 3 traps to the assembled gameboard as described below. Refer to Figure 1, on the cover, for the trap locations.

Boar's Head Trap: Insert the Boar's Head into the shield on the right back wall.

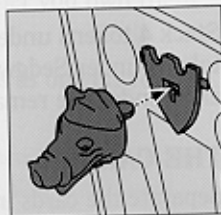

Safe Trap: Insert the 2 Safe Trap pegs into the 2 gameboard holes in the Vault room. Then place the metal piggybank on the chute, from the opening in the back.

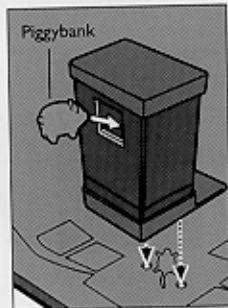

Suit of Armor Trap: Insert the 2 Suit of Armor base pegs into the 2 gameboard holes in the Parlor Room. Then place the Suit of Armor on top of the base.



THE HEIR PAWNS

Carefully remove the 16 Heir pawns from the parts sheet. Fit each pawn into a stand. Then place *all 16 pawns* on the Red Chair spaces around the dining room table, one pawn to a space. Pawns may be placed in any order around the table.

THE WILL AND MONEYBAG TOKENS

Carefully remove the Will and the 20 moneybag tokens from the parts sheet. Place the Will near the gameboard. Place the moneybag tokens faceup on the yellow spaces below the heirs, as follows:

Stack 4 tokens under Spritzzy; stack 2 tokens under Sedgwick; place 1 token each under the remaining 14 heirs.

THE CARDS

Separate the cards into 2 decks: the Heir cards (16) and the Playing cards (32).



Heir cards



Playing cards

The Heir Cards: Shuffle the Heir cards and deal them out *face down*, according to the number of players. Place any extra cards *face down*, out of the game.



2-player game:
Deal 6 cards to each player.

3-player game:
Deal 5 cards to each player.

4-player game:
Deal 4 cards to each player.

You own the Heir pawns that match the Heir cards in your hand. *Always keep your cards secret from your opponents!*

The Playing Cards: The cards in this deck allow you to do special things on your turn, like spring traps and move pawns to other rooms.

Remove the *Clock Strikes Midnight* card from the deck. Shuffle the remaining cards, then place the deck *face down* within reach of all players.



Place the *Clock Strikes Midnight* card *face down* on the bottom of the deck. When this card is drawn, the game is over!

GAME RULES

Filthy-rich heiress to a kitty-litter empire, sweet Aunt Agatha has finally passed on. Her “doting” heirs have gathered at her mansion for a reading of her Will. But to collect their inheritance, the greedy guests must escape from the treacherous, trap-filled mansion by midnight!

At the stroke of twelve, anyone still inside gets nothing. Those who get “knocked off” forfeit their shares to other heirs. And if *no one* survives, Agatha’s *entire fortune* goes to The Pet Pals Retirement Home. What an odorous state of affairs!

If you dare to claim your share, beware of the safe that’s anything *but* safe. Avoid the shaky suit of armor. And watch that top step on the stairway — it’s a *doozy!* One false move, and it’s “heir today, gone tomorrow”!

OBJECT

Collect moneybag tokens by moving your Heir pawns out the Front Door of the mansion. Spring traps to “knock off” your opponents’ pawns, and try to keep your *own* pawns from getting “knocked off.”

The game ends when the *Clock Strikes Midnight* card is drawn, or when no heirs are left inside the mansion. To win, be the player with the most moneybag tokens!

HOW TO PLAY

All players sit facing the front or side of the gameboard. Each player rolls one die. The highest roller goes first. Play then continues to the left.

ON YOUR TURN

On each of your turns, do the following three actions:

1. **ROLL** both dice, then move two pawns;
2. **DRAW** one Playing card for each pawn you moved onto a Trap space;
3. **PLAY** one or more cards if you can, or wish to do so.

Your turn ends after you have played your card(s) and followed the directions on them. All three actions are explained below.

1. Roll and Move

Roll both of the dice, then move two *different* pawns, one pawn for each die. For example, if you roll a 4 and a 6, you can move any pawn 4 spaces, and any *other* pawn 6 spaces.

Special “Doubles” Rule: If you roll doubles, you may either move *one* pawn the total amount of both dice, or *two* pawns (one pawn for each die).

PAWN MOVEMENT RULES

- You may move *any* pawns on the gameboard, whether you own them or not.
- Each space counts as one on your die roll.
- Always move a pawn by the full die count. *Exception:* You don’t need exact count to move a pawn out the Front Door.
- A pawn can move vertically or horizontally to an adjoining space, but not diagonally.
- You cannot pass through or land on a space occupied by another pawn.
- You can move a pawn onto plain colored spaces, and onto *Special spaces* (described below).
- You *cannot* move a pawn onto rugs, plants, logs, walls, or furniture. *Exception:* Pawns *can* move onto the Red Chair spaces around the dining room table.



- **Backtracking:** You can move a pawn onto the same space more than once on a single move, if you wish to do so. (This rule allows you to land on Trap spaces more often!)

The examples below show how you *can* and *can't* move a pawn.

On a die roll of 3, you can move a pawn as shown here:

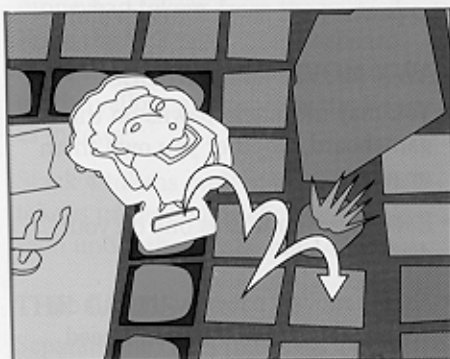

Moving from space to adjoining space

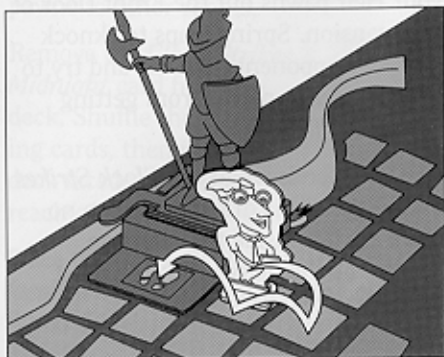

Backtracking

You can't move a pawn as shown here:

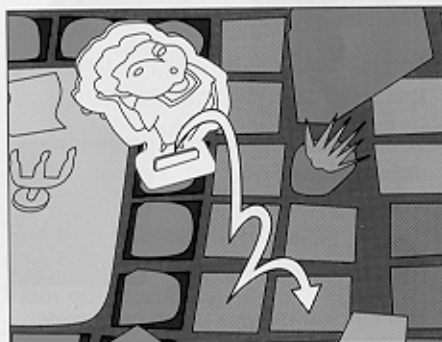

Moving diagonally

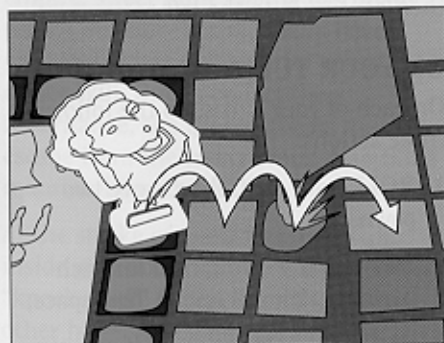

Moving onto a potted plant

SPECIAL SPACES



Secret Passage spaces:

Each room has a Secret Passage space. You can use these spaces to take shortcuts from room to room.

To do this, move a pawn onto an unoccupied Secret Passage space from any adjoining space, counting it as one on your die roll. Then move to any *other* unoccupied Secret Passage space, counting it as one on your die roll. Continue moving in the new room, if you have more spaces left to move. See the example at right.

USING A SECRET PASSAGE

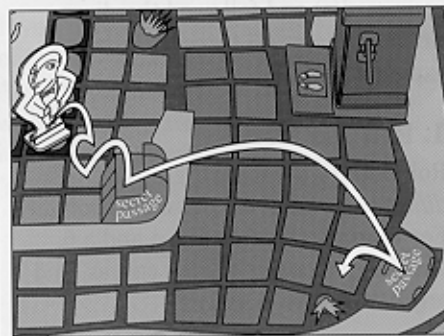

On a die roll of 5, you can use these Secret Passages to move from the Great Room to the Vault Room.



Trap Spaces: Each trap has a Trap space with footprints on it. Try to move opponents' pawns onto Trap spaces, so that you (or another player) can "spring the trap" to knock them off! You must move onto a Trap space by exact count, from an adjoining arrow space. (See *Stair spaces*, below, for the exception.)

The example below shows how to move onto a Trap space.

MOVING ONTO A TRAP SPACE

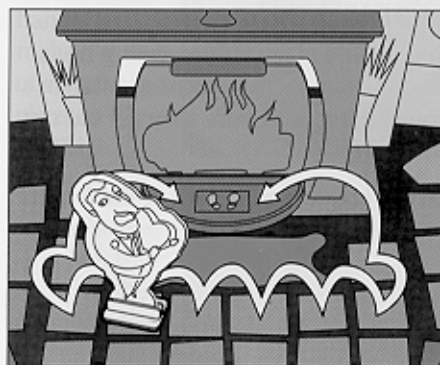

You can move this pawn onto the Fireplace Trap space with a die roll of 3 or 6. (You cannot move the pawn onto the rug.)

Once a pawn is on a Trap space, any player can, on his or her turn, "spring the trap" by playing the matching Trap card. See *HOW TO SPRING A TRAP*, on page 10.

Stair spaces: These are the 4 spaces leading up to the Stair Trap space. You can move a pawn onto the bottom 2 Stair spaces *only* from the arrow spaces next to them. Pawns may move from one Stair space to any adjoining Stair space. See the examples at right.

MOVING ONTO STAIR SPACES



On a die roll of 3, you can move this pawn directly onto the Stair Trap space.

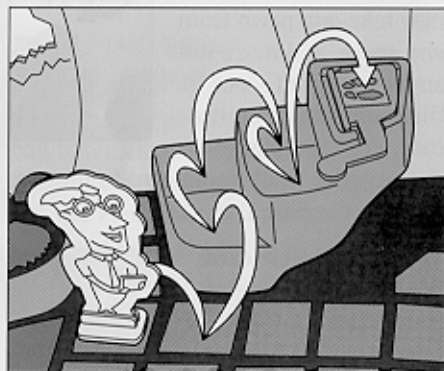

On a die roll of 6, here's one way you can move this pawn up the stairway to the Stair Trap space.

2. Draw a Playing Card

After your move is complete, you may draw one Playing card for each pawn you moved onto a Trap space. There's no limit to the number of Heir cards and Playing cards you can hold in your hand.

To draw a Playing card, take the top card from the deck and place it in your hand. Keep your cards secret from your opponents!

3. Play One or More Cards

Now decide whether you can, or want to, play one or more of the Playing cards in your hand.

You can play as many Trap cards as you wish on a turn; in *addition* or *instead*, you can play *one* of any other card. To play a card, place it faceup in the discard pile next to the deck, then follow the directions on it.

The 5 kinds of Playing cards are explained below.

Room card: When you play a Room card, you may take *any* pawn from *any* space, and move it to any unoccupied space in the room shown on the card. For example, you can play the Vault Room card to move a pawn to the Safe Trap space.



Take a New Heir card:

When you play one of these cards, you may take one Heir card from any opponent's hand. Choose one player to take a card from. That player holds up his or her Heir cards, and you pick one of them at random. Place your new Heir card in your hand, keeping it secret from your opponents.



Run for it! card:

When you play one of these cards, roll one die, then move a pawn of your choice the number of spaces shown on the die. These cards can help one of your pawns escape from the mansion, or prevent an opponent's pawn from escaping!



Trap card: Play one or more Trap cards on a turn, to spring *either* trap pictured on the card. Immediately after you play a Trap card, spring the trap! See *How to Spring a Trap*, below.



Wild Trap card: You can play one or more Wild Trap Cards on a turn, to spring *any* trap!



HOW TO SPRING A TRAP

You should play cards to spring traps on your opponents' pawns as often as you can, to make sure they get cut out of the Will!

Here's how to spring each of the 5 traps:

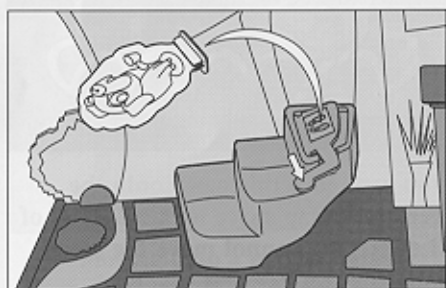

The Stair Trap: Push down on the lever handle on the top step, to make the pawn fall off the stairway. OOPS!

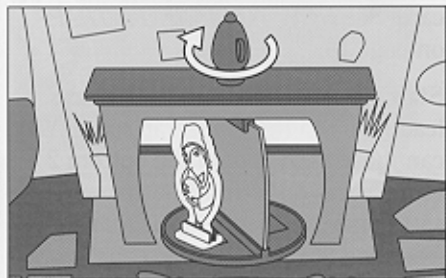

The Fireplace Trap: Rotate the urn to move the pawn around to the back of the fireplace. This heir is TOAST!

The Boar's Head Trap: Lift the lever from the back of the wall to release the Boar's head. BONK!



The Suit of Armor Trap: Push down on the lever handle to make the suit of armor topple over. CRASH!



The Safe Trap: Push down on the lever handle to make the piggybank shoot down the chute. CLUNK!

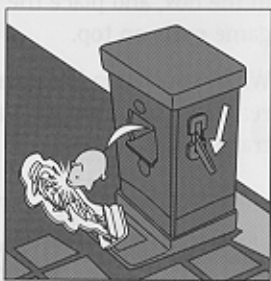

"KNOCKING OFF" A PAWN

After springing a trap, remove the pawn from the Trap space, *whether or not it was actually knocked over*. Then reset the trap.

The player who owned the "knocked off" pawn must place the matching Heir card faceup on the table, and place the "knocked off" pawn on top of it. The card and the pawn are now out of the game, and that heir collects nothing! *Note:* If no one owned the "knocked off" pawn, just place it aside, out of play.

Slide the share to the next heir. Now find the "knocked-off" heir on the Will, and move his or her moneybag token(s) in the direction of the arrow to the next surviving heir. See the example below.



Poor Pierre's been "knocked off" on the stairs! Slide his moneybags down to Charity, the next heir in line.

ESCAPING FROM THE MANSION

The only way you can collect moneybag tokens is to escape from the mansion by moving one of *your* pawns out the Front Door. To escape, move the pawn onto (or beyond) the "welcome" stone from either of the two spaces adjoining it. See the example below.



On a die roll of 5, you move your Dusty pawn out the Front Door! Now you can collect her moneybags!

Once your pawn has escaped, place your matching Heir card faceup on the table, and stand your escaped pawn on top of it. Now collect the moneybag token(s) from below the Heir on the Will, and place them in front of you.

RUNNING OUT OF PAWNS

If you lose your last pawn (either by escaping or getting "knocked off"), you can continue playing, even though you have no Heir cards. Try to acquire new Heir cards by playing *Take a New Heir* cards during your turns.

STRATEGY TIPS

Bluffing: A good way to keep your pawns secret is to bluff your opponents. You can do this by moving your opponents' pawns toward the Front Door. You can also move your own pawns onto Trap spaces. Not only will this confuse your opponents; it will also allow you to draw cards.

Keep an eye on the Will! Keep track of where the moneybag tokens are located on the Will. You should concentrate on getting your richest heirs out first. It's also a good idea to save a *Run for it!* card, to help a rich heir escape before your opponents can move it away from the Front Door!

The "Retrap" move: It's often possible to move a pawn off of a Trap space, then back onto it again in a single move. See the example below. This is an easy way to get a Playing card. The more cards you can draw, the better, especially toward the end of the game!



On a die roll of 5, here's one way you can move Sedgwick off the Suit of Armor Trap space, then right back onto it!

HOW TO WIN

The game ends as soon as either of the following happens:

- A player draws the *Clock Strikes Midnight* card; or
- The last pawn on the gameboard either escapes or gets "knocked off."

Players count up their moneybag tokens. The player with the most tokens wins the game!

EASY STORAGE!

Finished playing? It only takes a minute to store your game. Simply remove the assembled traps from the gameboard. Carefully lift off the 3 back walls and remove the 4 clips. Lay the folded gameboard, the Will and the walls flat in the box, and place the remaining game parts on top.

When you're ready to play again, just reattach the clips, walls and assembled traps to the gameboard.

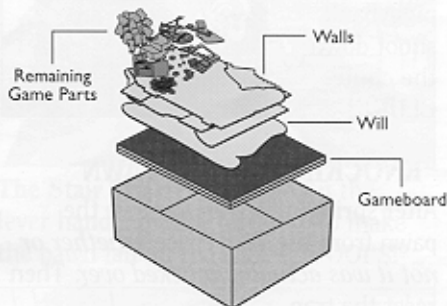

We will be happy to hear your questions or comments about this game. Write to: Hasbro Games, Consumer Affairs Dept., P.O. Box 200, Pawtucket, R.I. 02862. Tel: 888-836-7025 (toll-free). Canadian consumers please write to: Hasbro, Canada, P.O. Box 267, Station A, Longueuil, Quebec J4H 3X6.

© 2002 Hasbro, Pawtucket, RI 02862. All Rights Reserved.
PRINTED IN U.S.A. 40332



PROOF OF PURCHASE



40332

151
Dead End
Drive™