

TRANSFORMERS

REVENGE OF THE FALLEN™



RECON IRONHIDE™
AUTOBOT®

! WARNING:

CHOKING HAZARD-Small parts.
Not for children under 3 years.

AGES 5+

93832/83972 Asst.

TRANSFORMERS.COM

NOTE: Some parts are made to detach if excessive force is applied and are designed to be reattached if separation occurs. Adult supervision may be necessary for younger children.

CHANGING TO ROBOT

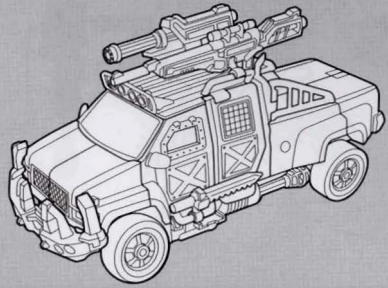

RECON IRONHIDE

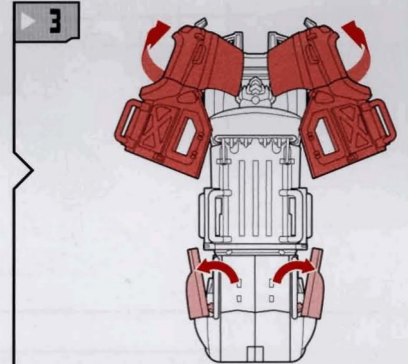
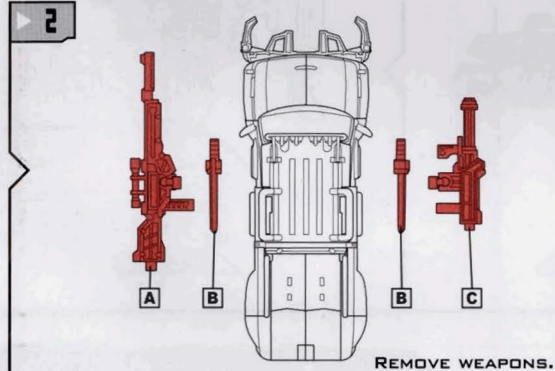
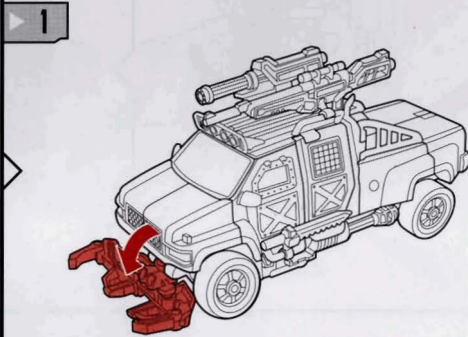

4

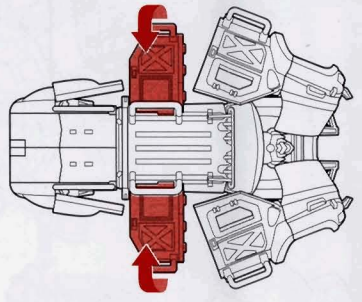

5

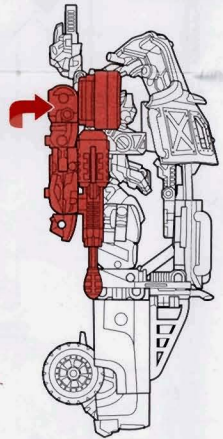
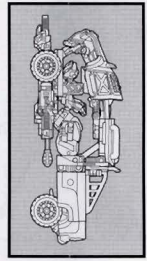

6

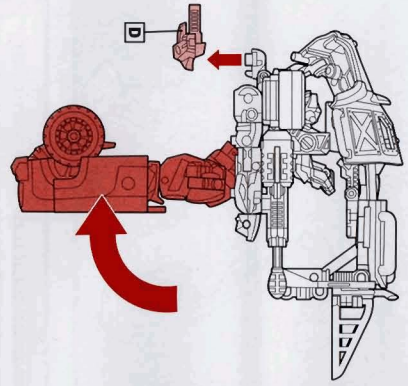

7

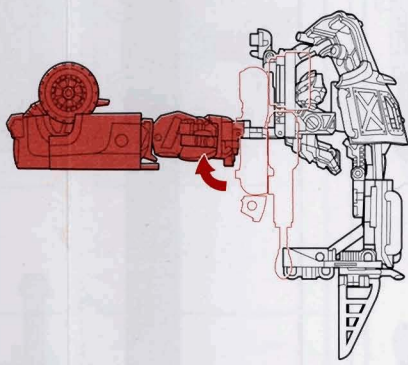

8

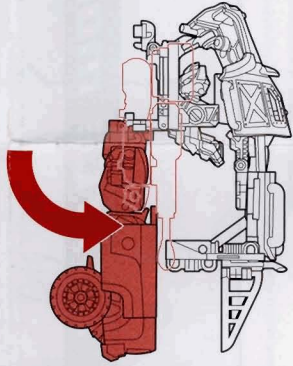

9

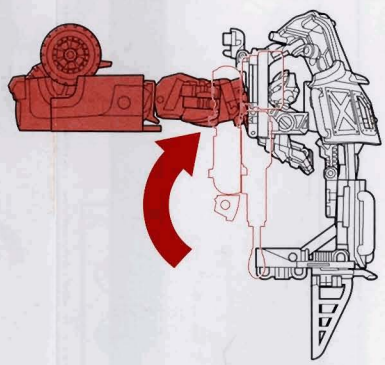

10

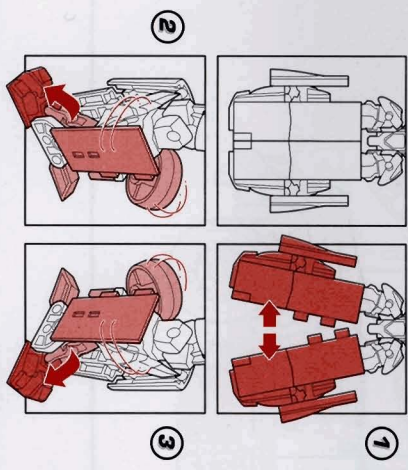

11

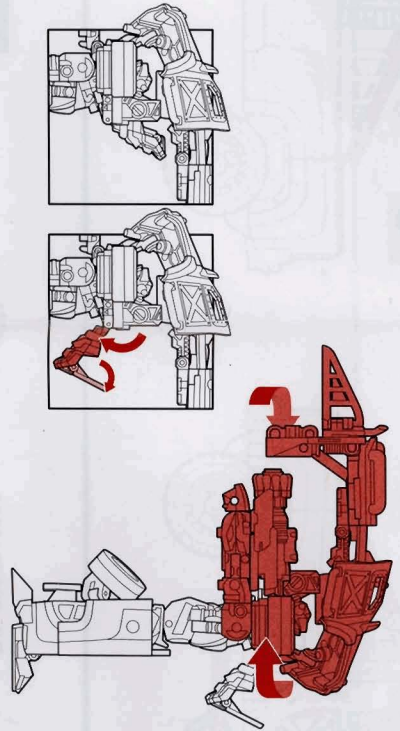

12

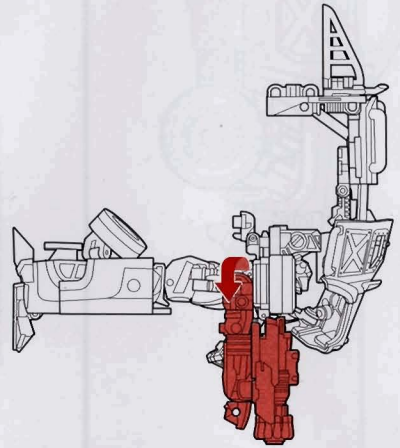

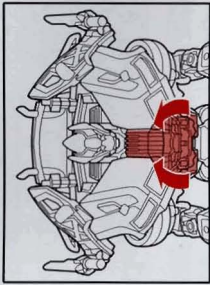
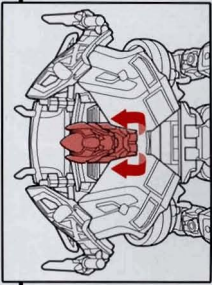

16

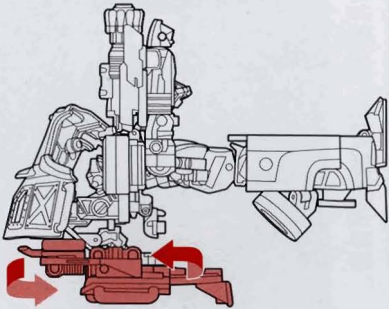

15

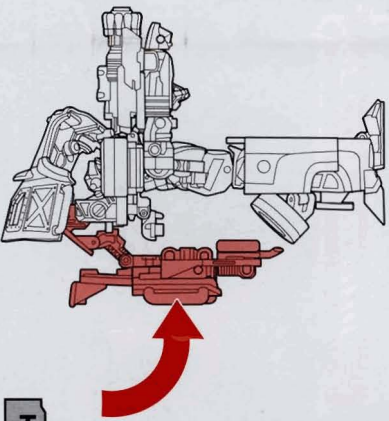

14

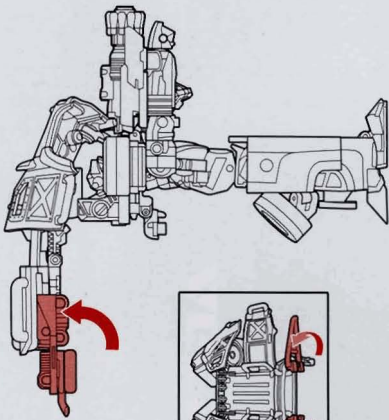

13

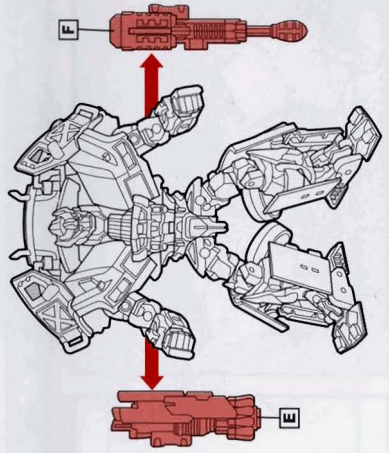

20

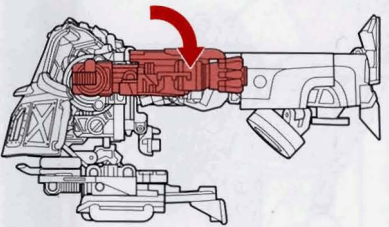

19

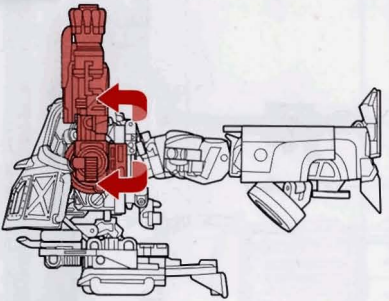

18

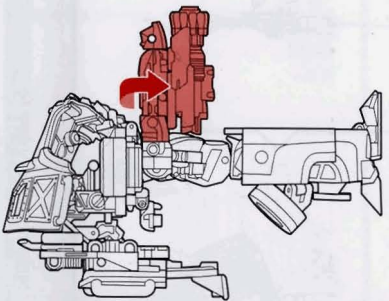

17

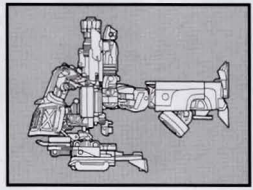

ROBOT MODE

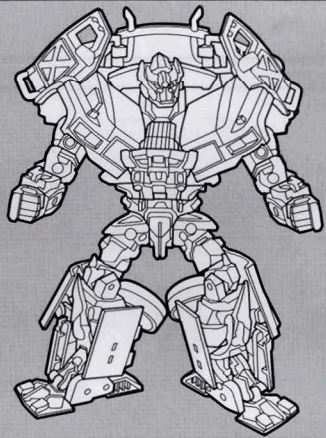

**REVERSE ORDER OF INSTRUCTIONS
TO CONVERT BACK INTO VEHICLE.**

BATTLE MODE

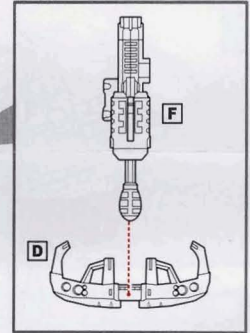
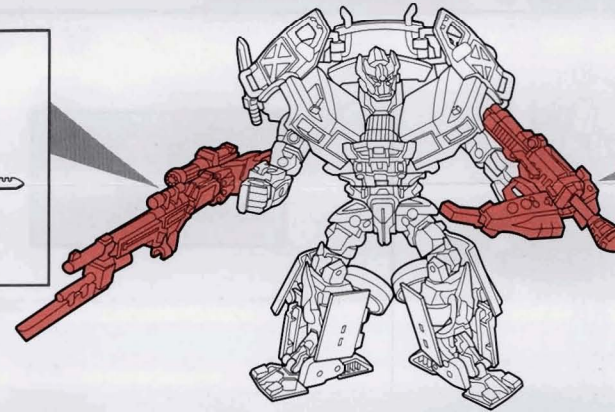
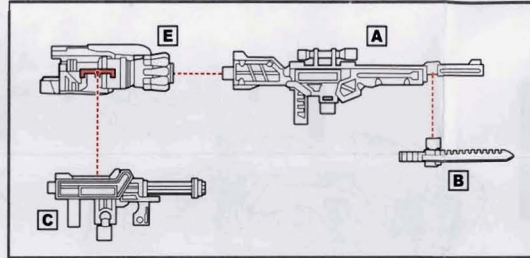

TO LAUNCH MISSILE:
1. INSERT MISSILE.
2. PUSH TO FIRE.

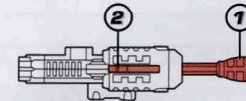

MISSILE STORAGE

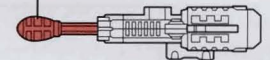

BATTLE MODE

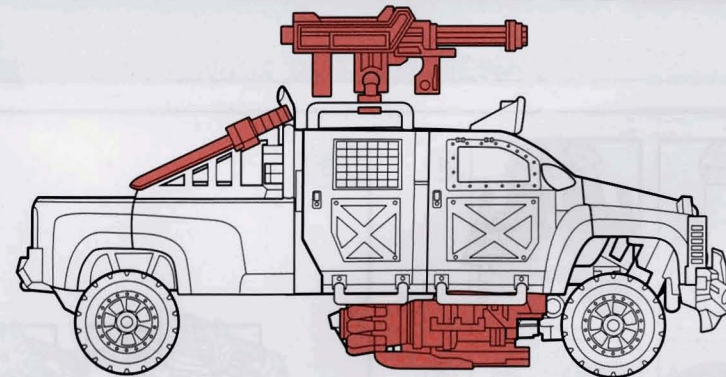
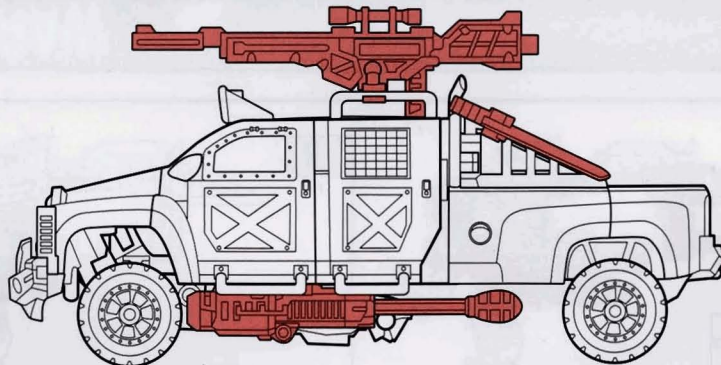

Some poses may require hand support.

P/N 6987840000



© 2009 DreamWorks LLC and Paramount Pictures Corporation
® and/or TM® & © 2009 Hasbro. All Rights Reserved.
TM & ® denote U.S. Trademarks.
Manufactured under license from Tomly Company, Ltd.

**DREAMWORKS
PICTURES**



Topkick and all related Emblems
and vehicle body designs are
General Motors Trademarks used
under license to Hasbro, Inc.



**Not suitable for children
under 3 years because of
small parts - choking hazard.**